

© Ignitions 2014

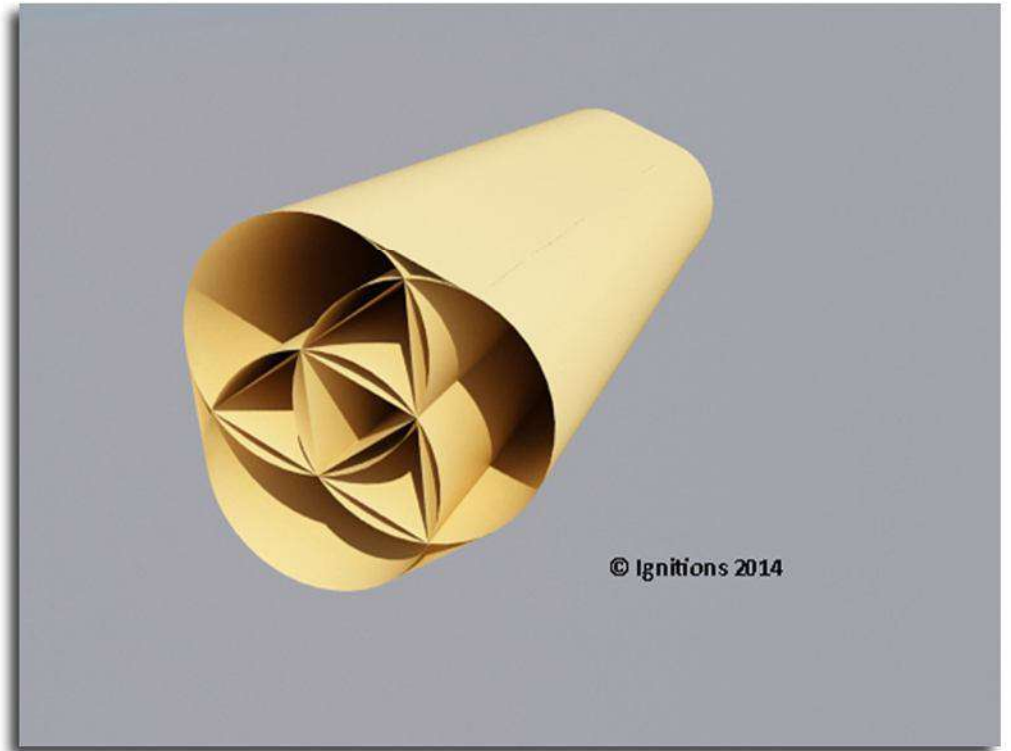

© Ignitions 2014



ΤΟΜΗ Α-Α

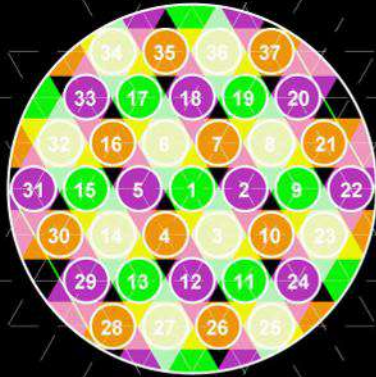

ΤΟΜΗ Β-Β

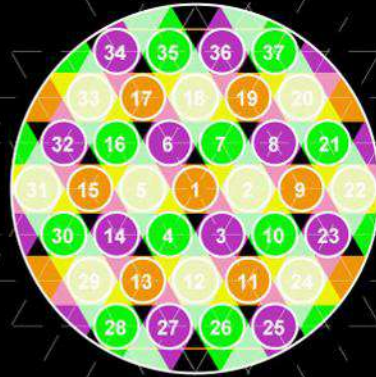

ΤΟΜΗ Γ-Γ

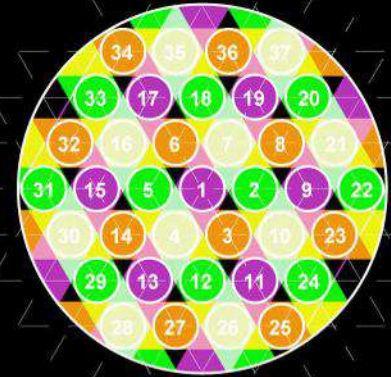

ΤΟΜΗ Δ-Δ

**ΤΟΜΗ Ε-Ε ΟΠΩΣ Α-Α**  
**ΤΟΜΗ Ζ-Ζ ΟΠΩΣ Β-Β**  
**ΤΟΜΗ Η-Η ΟΠΩΣ Γ-Γ**  
**ΤΟΜΗ Θ-Θ ΟΠΩΣ Δ-Δ**  
**(ΤΟΜΗ Ι-Ι ΟΠΩΣ Α-Α)**

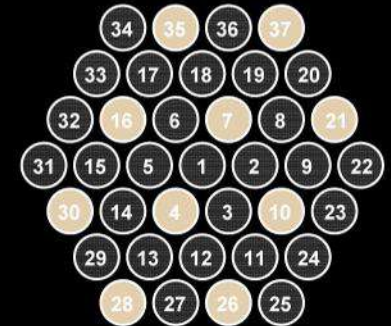
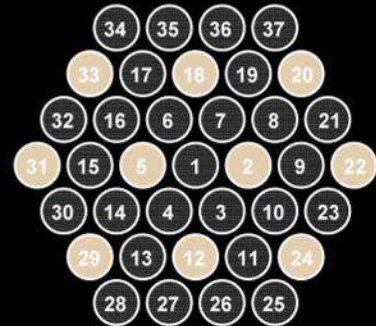
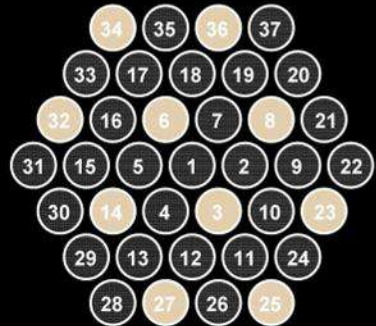
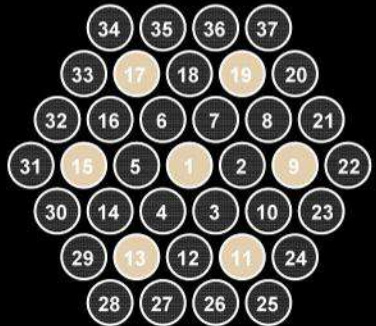

-  ΧΩΡΙΣ ΔΙΑΣΤΑΥΡΩΣΗ
-  2 ΔΡΟΜΩΝ ΔΙΑΣΤΑΥΡΩΣΗ
-  3 ΔΡΟΜΩΝ ΔΙΑΣΤΑΥΡΩΣΗ
-  4 ΔΡΟΜΩΝ ΔΙΑΣΤΑΥΡΩΣΗ

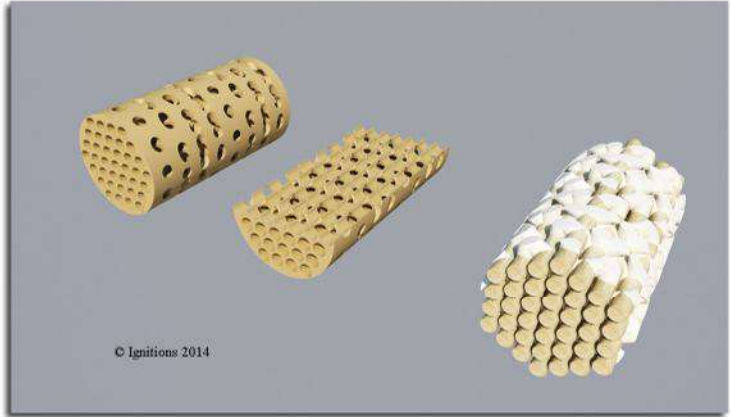
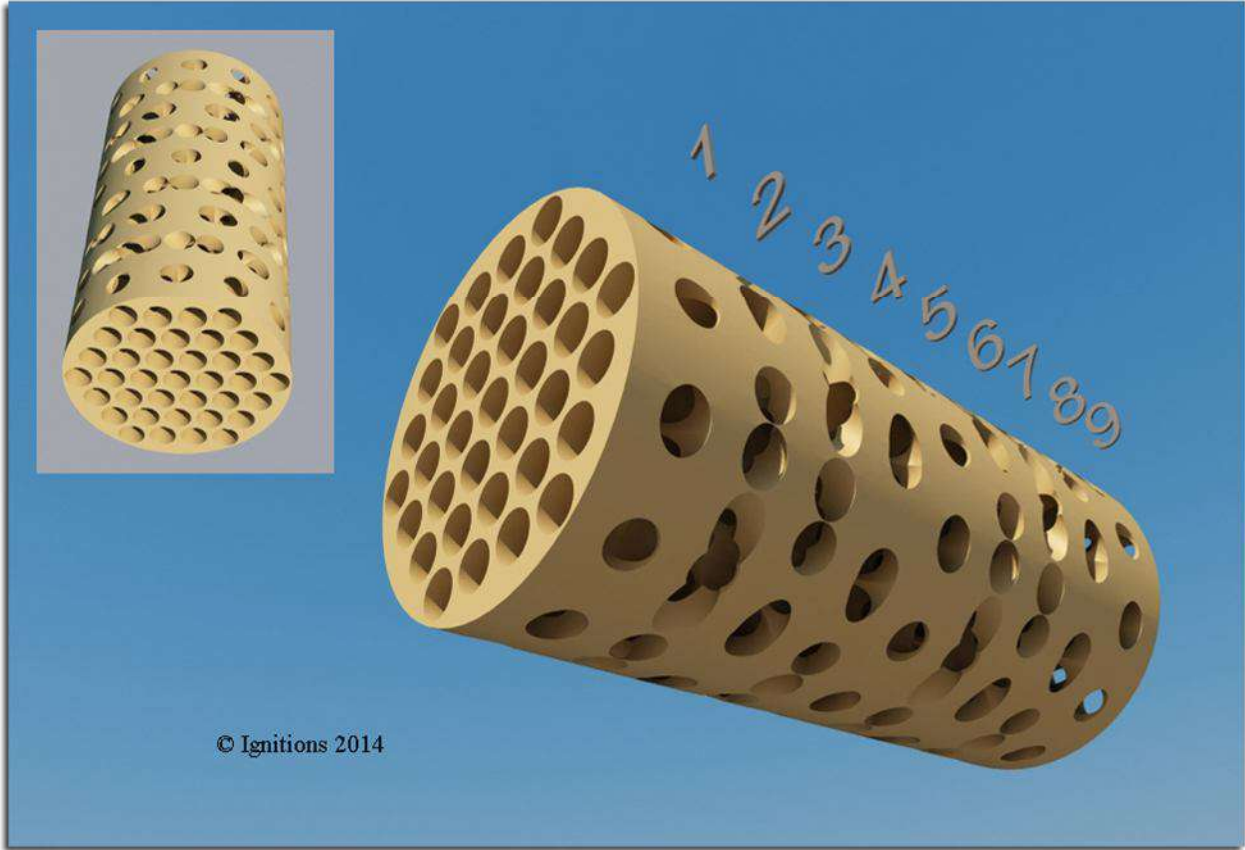



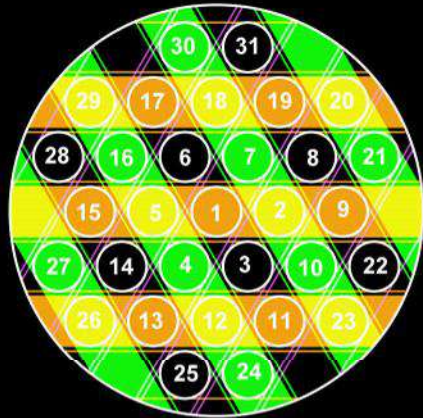

ΤΟΜΗ Α-Α

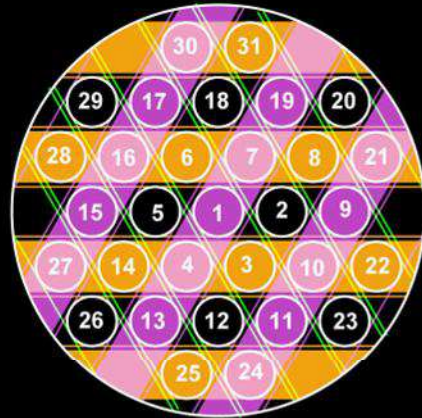

ΤΟΜΗ Β-Β

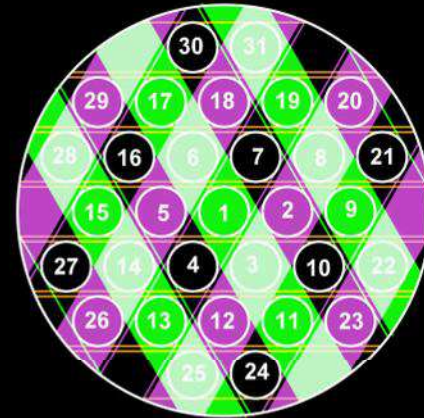

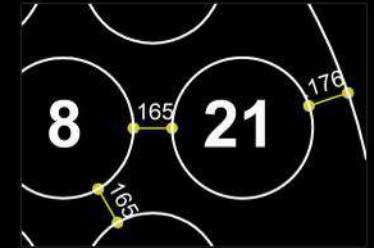

ΤΟΜΗ Γ-Γ

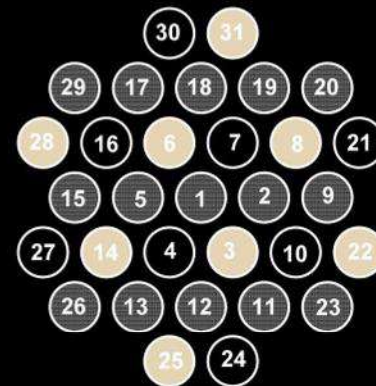
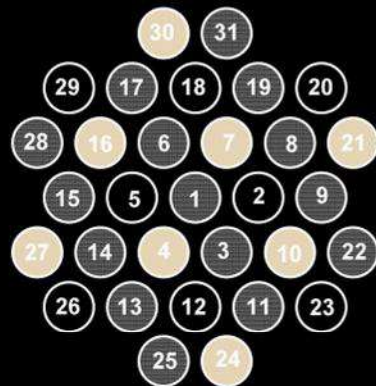
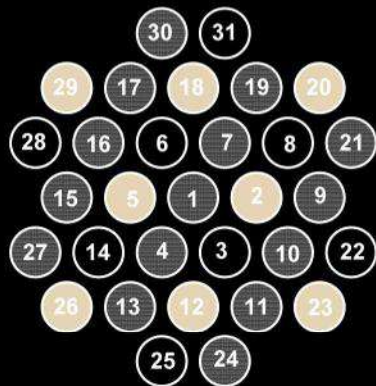

ΤΟΜΗ Δ-Δ ΟΠΩΣ Α-Α  
 ΤΟΜΗ Ε-Ε ΟΠΩΣ Β-Β  
 ΤΟΜΗ Ζ-Ζ ΟΠΩΣ Γ-Γ  
 ...



-  ΧΩΡΙΣ ΔΙΑΣΤΑΥΡΩΣΗ
-  2 ΔΡΟΜΩΝ ΔΙΑΣΤΑΥΡΩΣΗ
-  3 ΔΡΟΜΩΝ ΔΙΑΣΤΑΥΡΩΣΗ



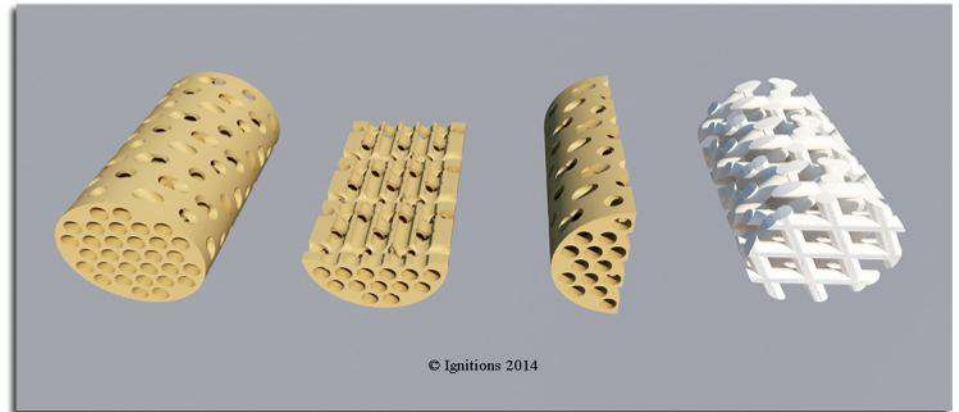
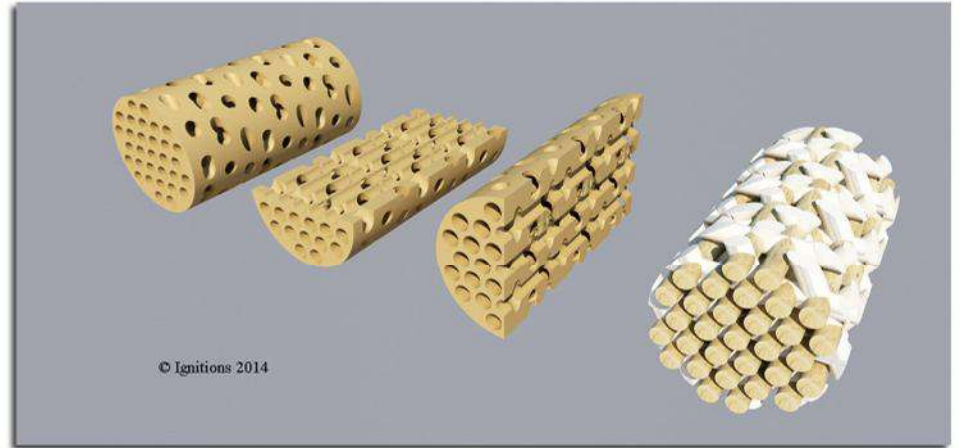
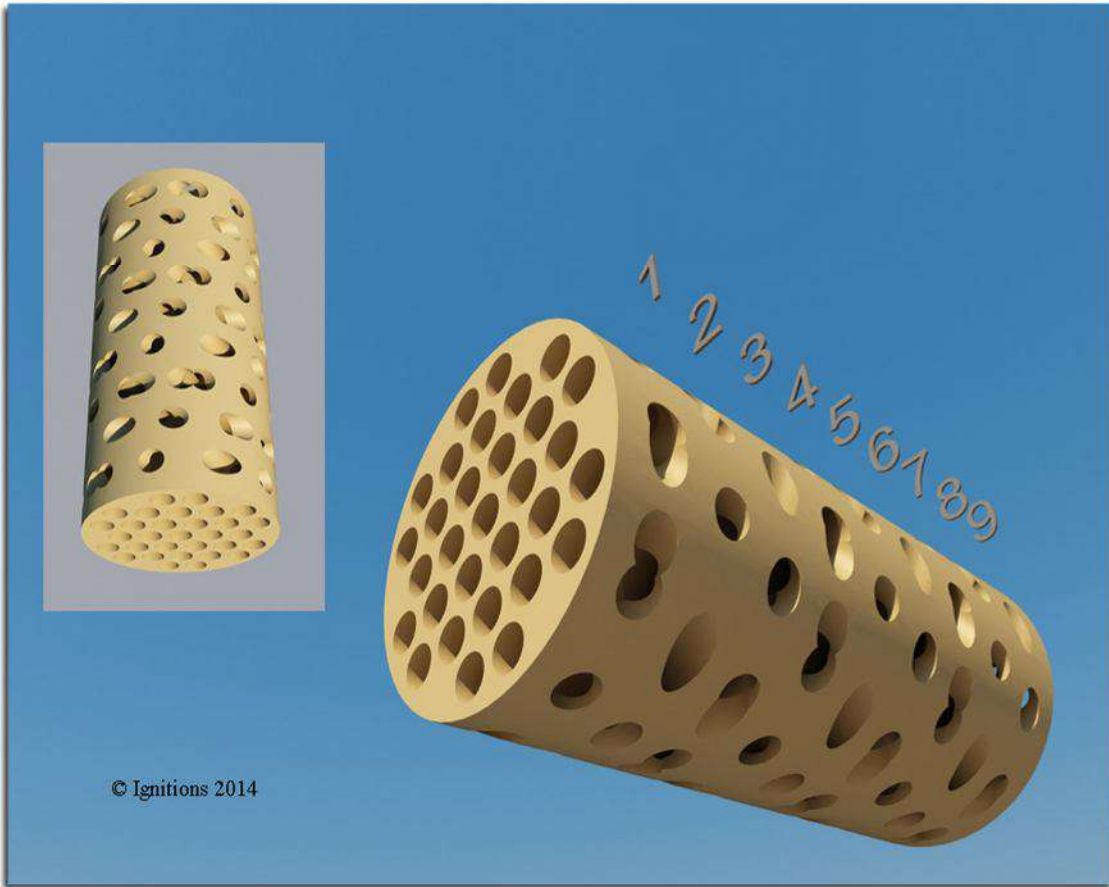

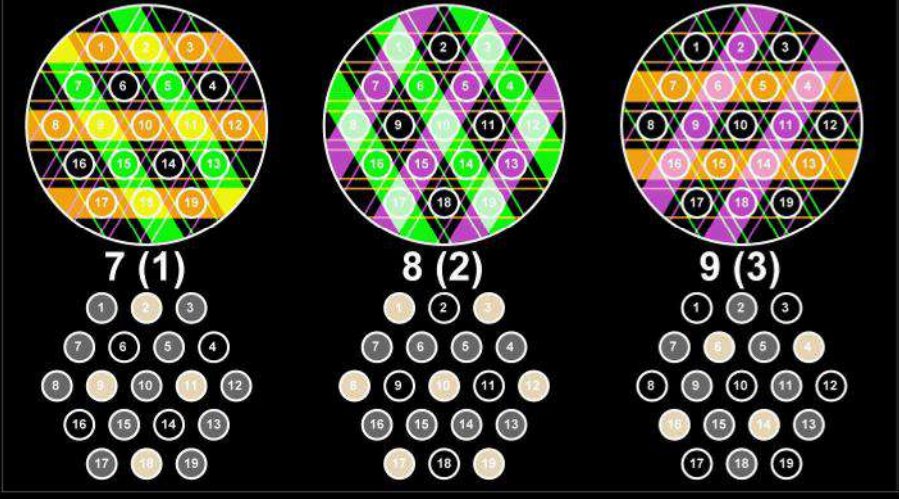
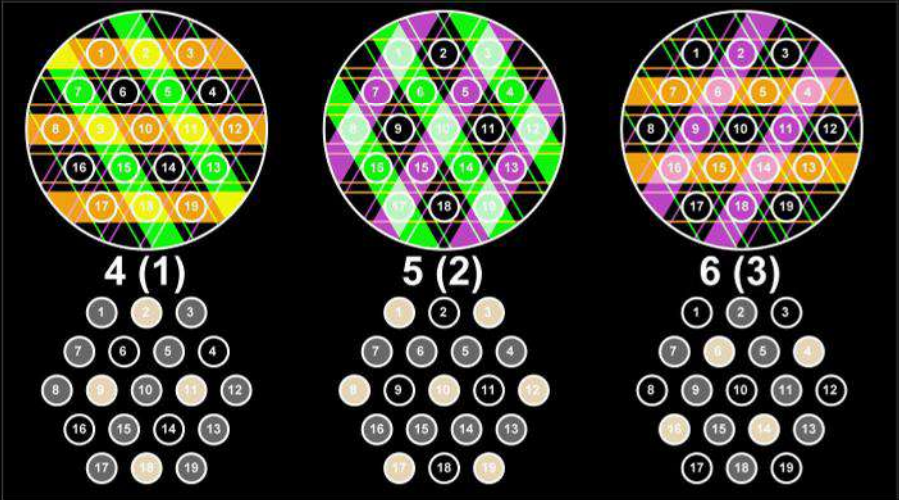
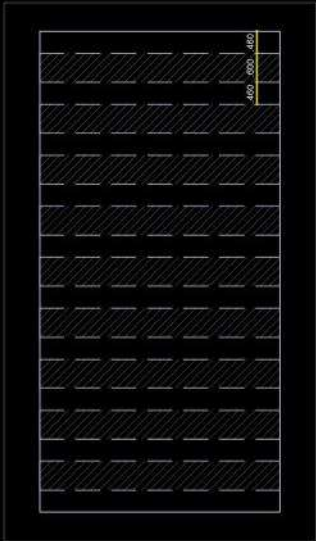
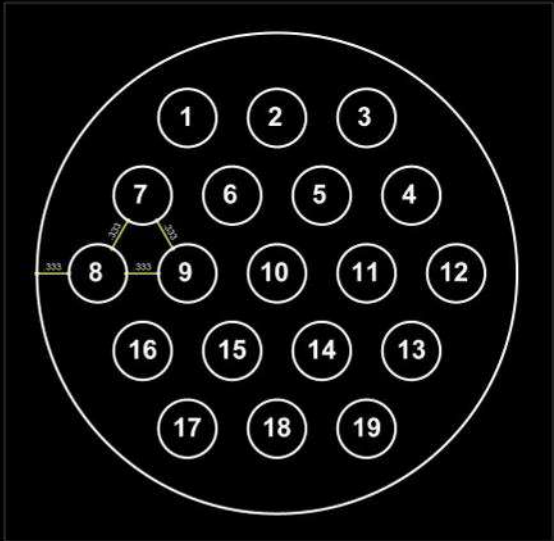
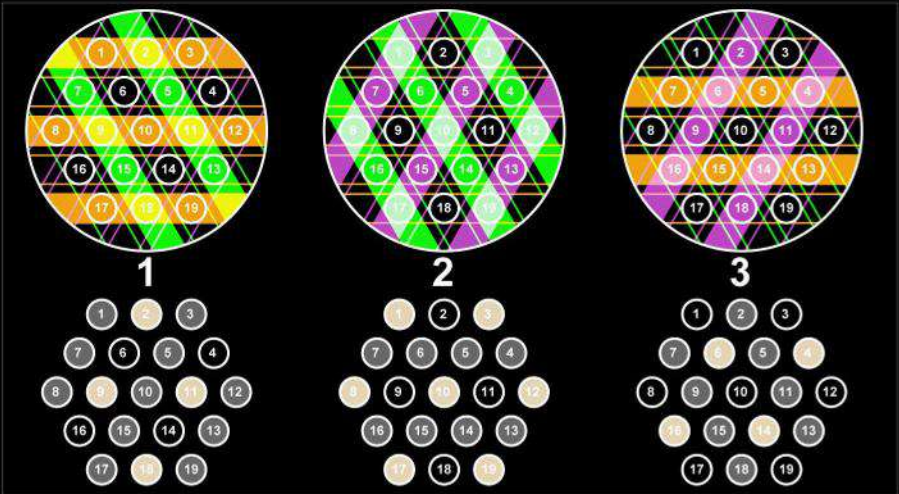

ΧΩΡΙΣ ΔΙΑΣΤΑΥΡΩΣΗ  
 2 ΔΡΟΜΟΝ ΔΙΑΣΤΑΥΡΩΣΗ  
 3 ΔΡΟΜΟΝ ΔΙΑΣΤΑΥΡΩΣΗ

	1	2	3	4	5	6	7	8	9	
1	1	1	1	1	1	1	1	1	1	9
2	1	0	2	1	0	2	1	0	9	9
3	1	1	1	1	1	1	1	1	1	9
4	0	2	1	0	2	1	0	2	1	9
5	1	0	2	1	0	2	1	0	2	9
6	1	1	1	1	1	1	1	1	1	9
7	2	1	0	2	1	0	2	1	0	9
8	1	1	1	1	1	1	1	1	1	9
9	2	1	0	2	1	0	2	1	0	9
10	1	1	1	1	1	1	1	1	1	9
11	1	0	2	1	0	2	1	0	2	9
12	0	2	1	0	2	1	0	2	1	9
13	1	0	2	1	0	2	1	0	2	9
14	0	2	1	0	2	1	0	2	1	9
15	1	1	1	1	1	1	1	1	1	9
16	2	1	0	2	1	0	2	1	0	9
17	1	1	1	1	1	1	1	1	1	9
18	1	1	1	1	1	1	1	1	1	9
19	19	19	19	19	19	19	19	19	19	9

© Ignitions 2014

19p\_min180\_9slice\_prop1



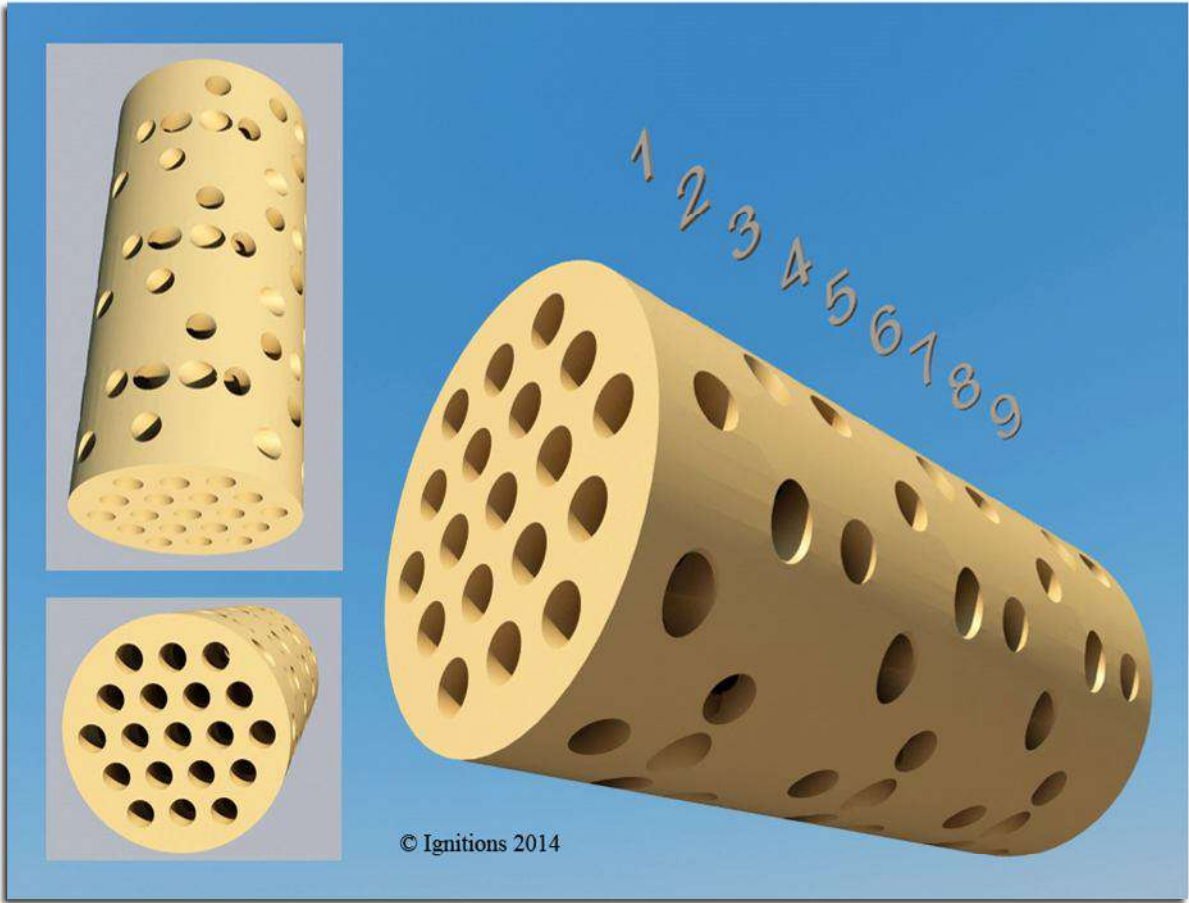



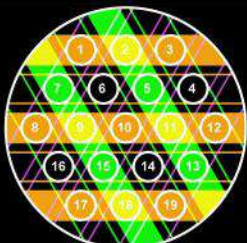

1

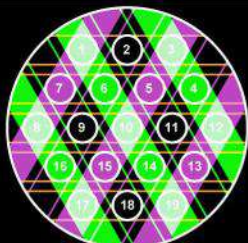
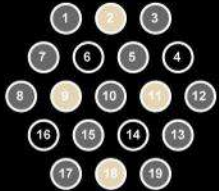

2

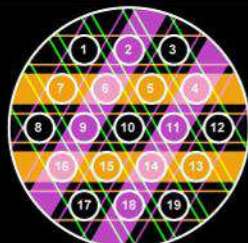
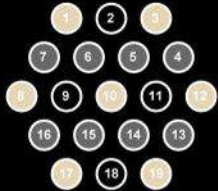

3

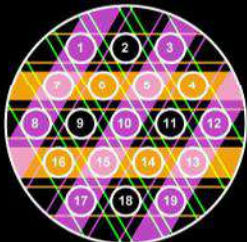
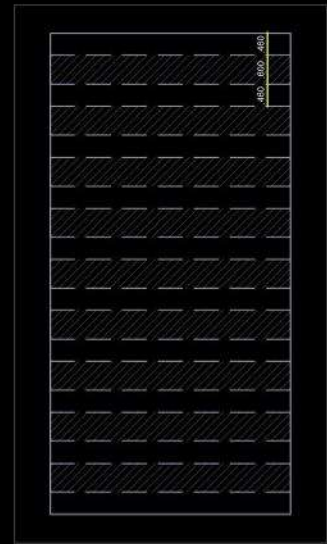
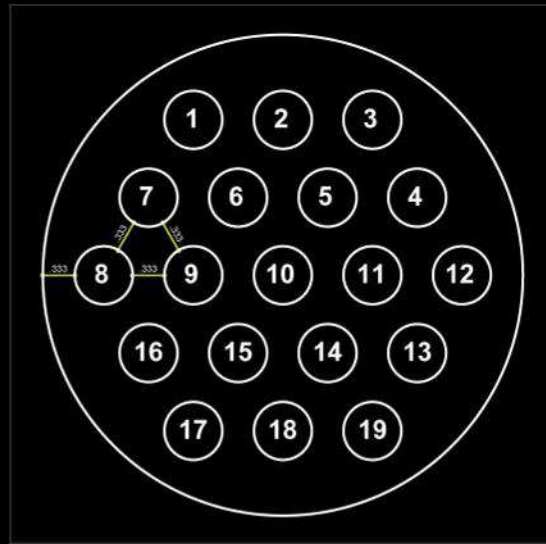

4

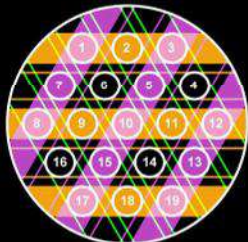

5

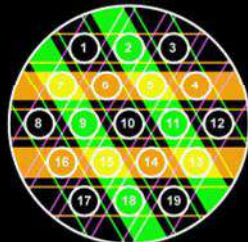
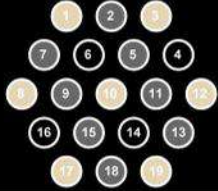

6



7

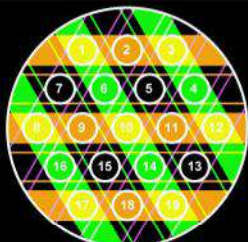
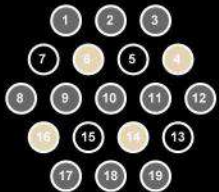

8

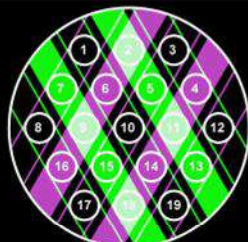
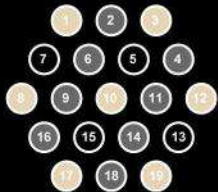

9

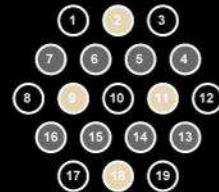

-  ΧΩΡΙΣ ΔΙΑΣΤΑΥΡΩΣΗ
-  2 ΔΡΟΜΩΝ ΔΙΑΣΤΑΥΡΩΣΗ
-  3 ΔΡΟΜΩΝ ΔΙΑΣΤΑΥΡΩΣΗ

	1	2	3	4	5	6	7	8	9	
1	1	2	0	1	2	0	1	2	0	9
2	2	0	1	0	1	1	1	1	2	9
3	1	2	0	1	2	0	1	2	0	9
4	0	1	2	1	0	1	2	1	1	9
5	1	1	1	2	1	2	0	0	1	9
6	0	1	2	1	0	1	2	1	1	9
7	1	1	1	2	1	2	0	0	1	9
8	1	2	0	1	2	0	1	2	0	9
9	2	0	1	0	1	1	1	1	2	9
10	1	2	0	1	2	0	1	2	0	9
11	2	0	1	0	1	1	1	1	2	9
12	1	2	0	1	2	0	1	2	0	9
13	1	1	1	2	1	2	0	0	1	9
14	0	1	2	1	0	1	2	1	1	9
15	1	1	1	2	1	2	0	0	1	9
16	0	1	2	1	0	1	2	1	1	9
17	1	2	0	1	2	0	1	2	0	9
18	2	0	1	0	1	1	1	1	2	9
19	1	2	0	1	2	0	1	2	0	9
	19	22	16	19	22	16	19	22	16	

© Ignitions 2014

19p\_min180\_9slice\_prop2

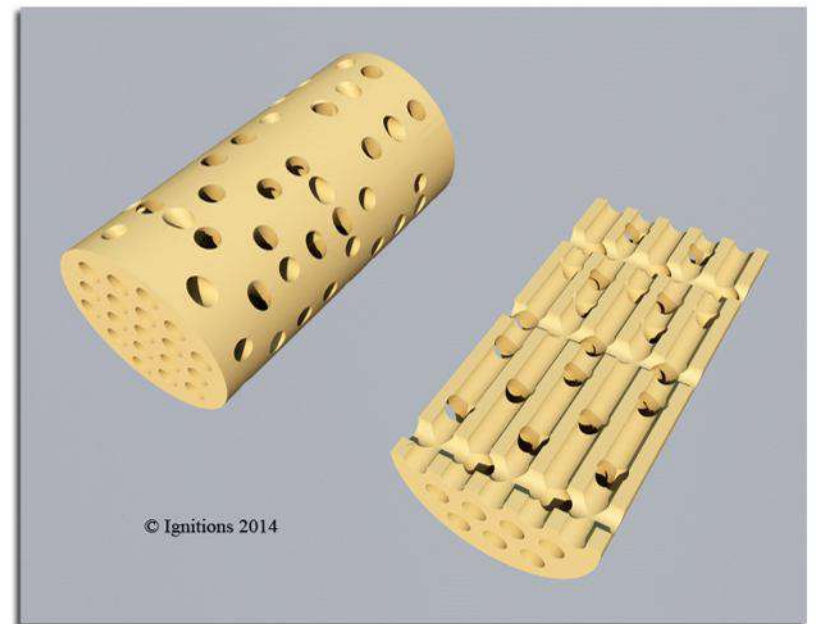
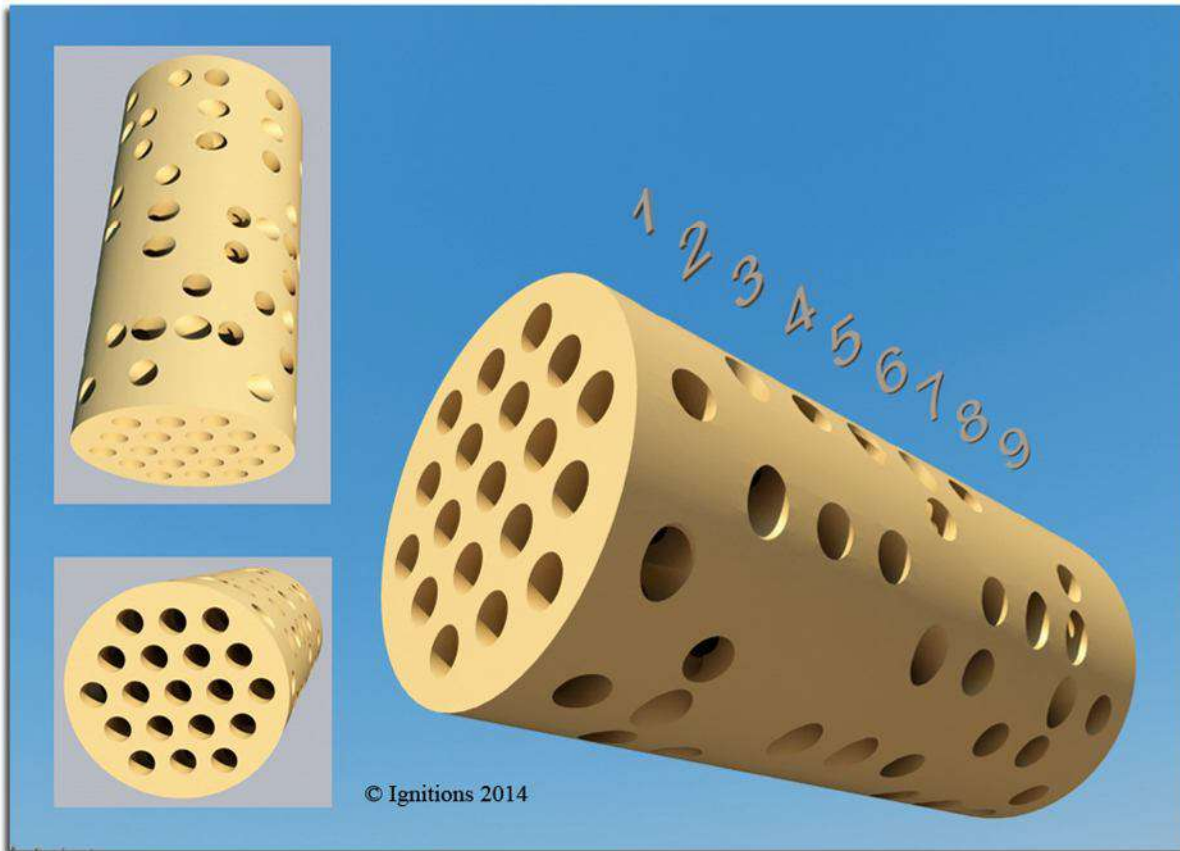



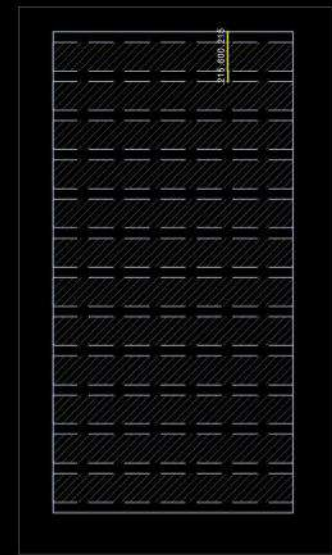
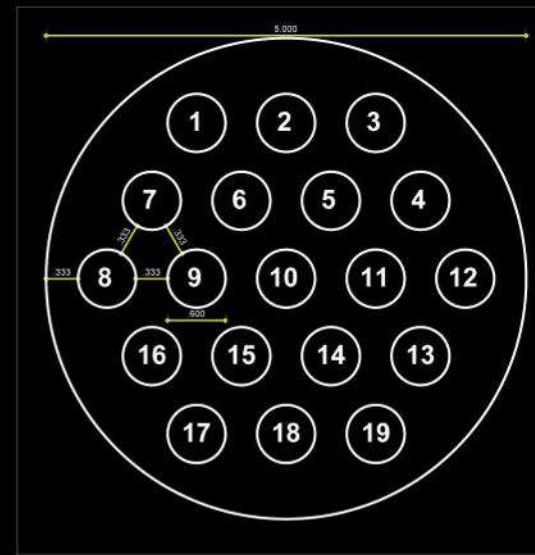
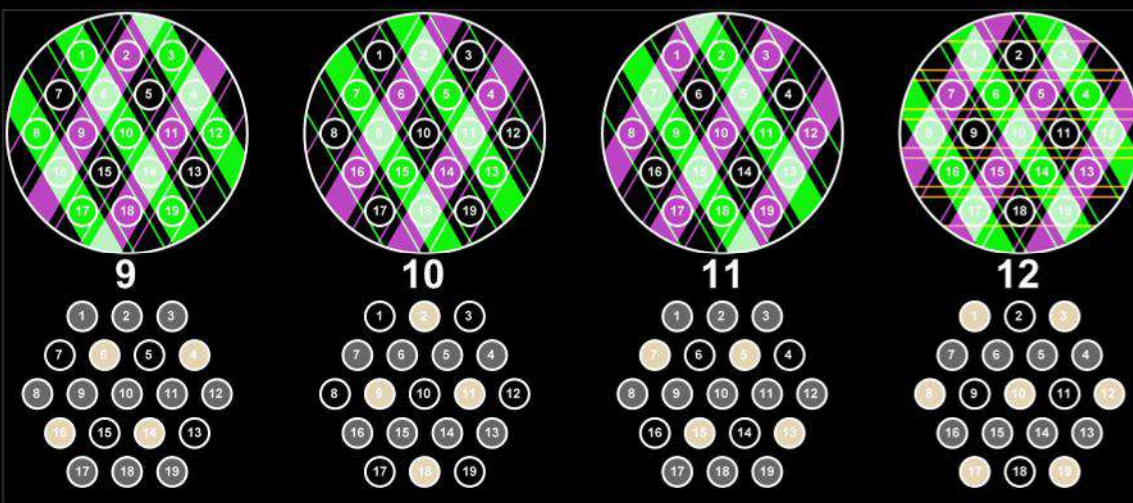
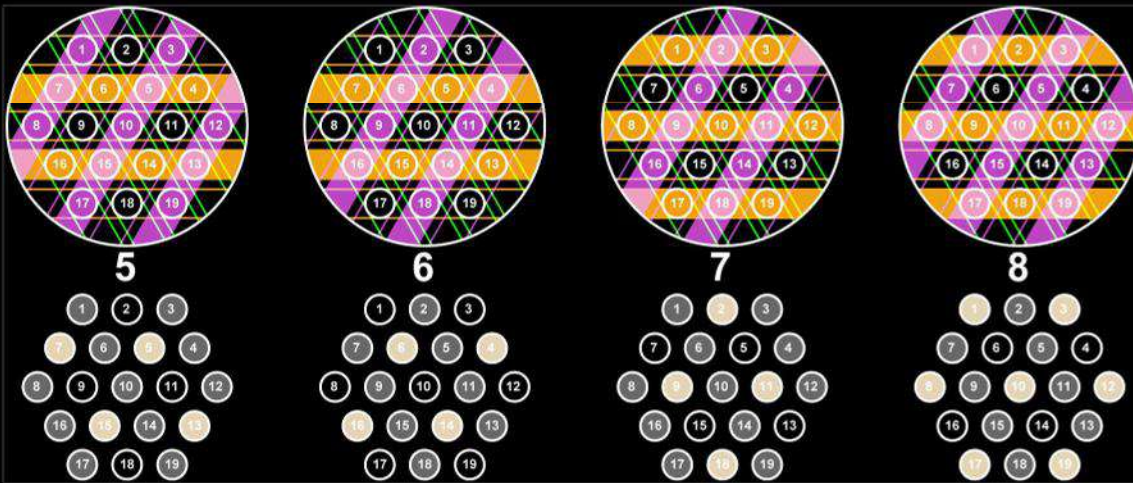
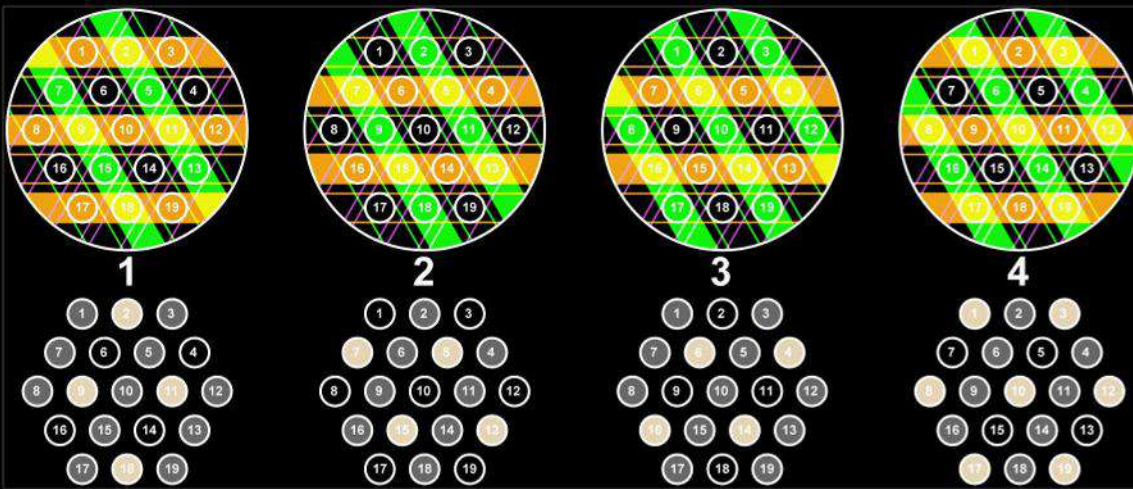

1	2	3	4	5	6	7	8	9	10	11	12	
1	0	1	2	1	0	1	2	1	0	1	2	12
2	1	0	1	0	1	2	1	1	2	1	0	12
3	0	1	2	1	0	1	2	1	0	1	2	12
4	0	1	2	1	1	2	1	0	2	1	0	12
5	1	2	1	0	2	1	0	1	0	1	2	12
6	0	1	2	1	1	2	1	0	2	1	0	12
7	1	2	1	0	2	1	0	1	0	1	2	12
8	1	0	1	2	1	0	1	2	1	0	1	2
9	2	1	0	1	0	1	2	1	1	2	1	0
10	1	0	1	2	1	0	1	2	1	0	1	2
11	2	1	0	1	0	1	2	1	1	2	1	0
12	1	0	1	2	1	0	1	2	1	0	1	2
13	1	2	1	0	2	1	0	1	0	1	2	1
14	0	1	2	1	1	2	1	0	2	1	0	1
15	1	2	1	0	2	1	0	1	0	1	2	1
16	0	1	2	1	1	2	1	0	2	1	0	1
17	1	0	1	2	1	0	1	2	1	0	1	2
18	2	1	0	1	0	1	2	1	1	2	1	0
19	1	0	1	2	1	0	1	2	1	0	1	2
19	16	19	22	19	16	19	22	19	16	19	22	

- ΚΟΡΜΗ ΔΙΑΣΤΑΥΡΩΣΗ
- 2 ΑΠΟΜΟΝ ΔΙΑΣΤΑΥΡΩΣΗ
- 3 ΑΠΟΜΟΝ ΔΙΑΣΤΑΥΡΩΣΗ

© Ignitions 2014

19p\_min180\_9slice\_prop3



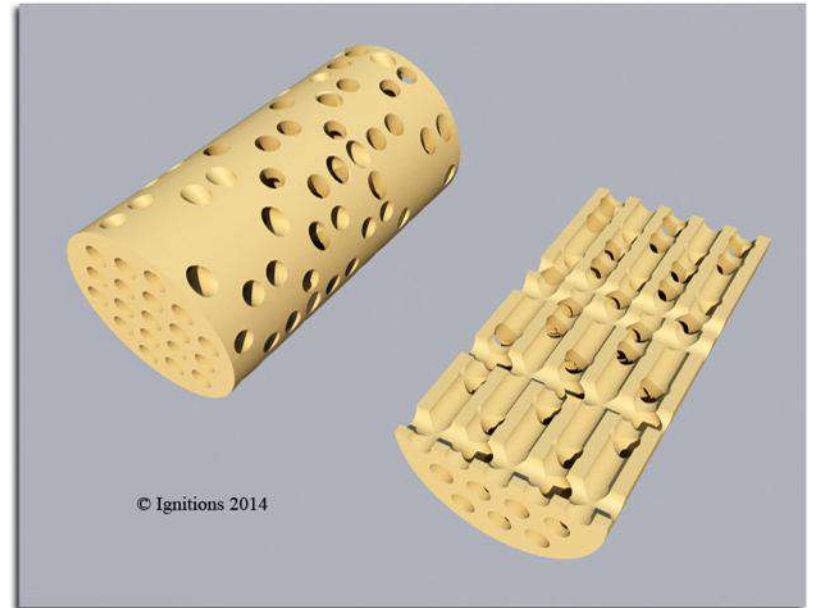
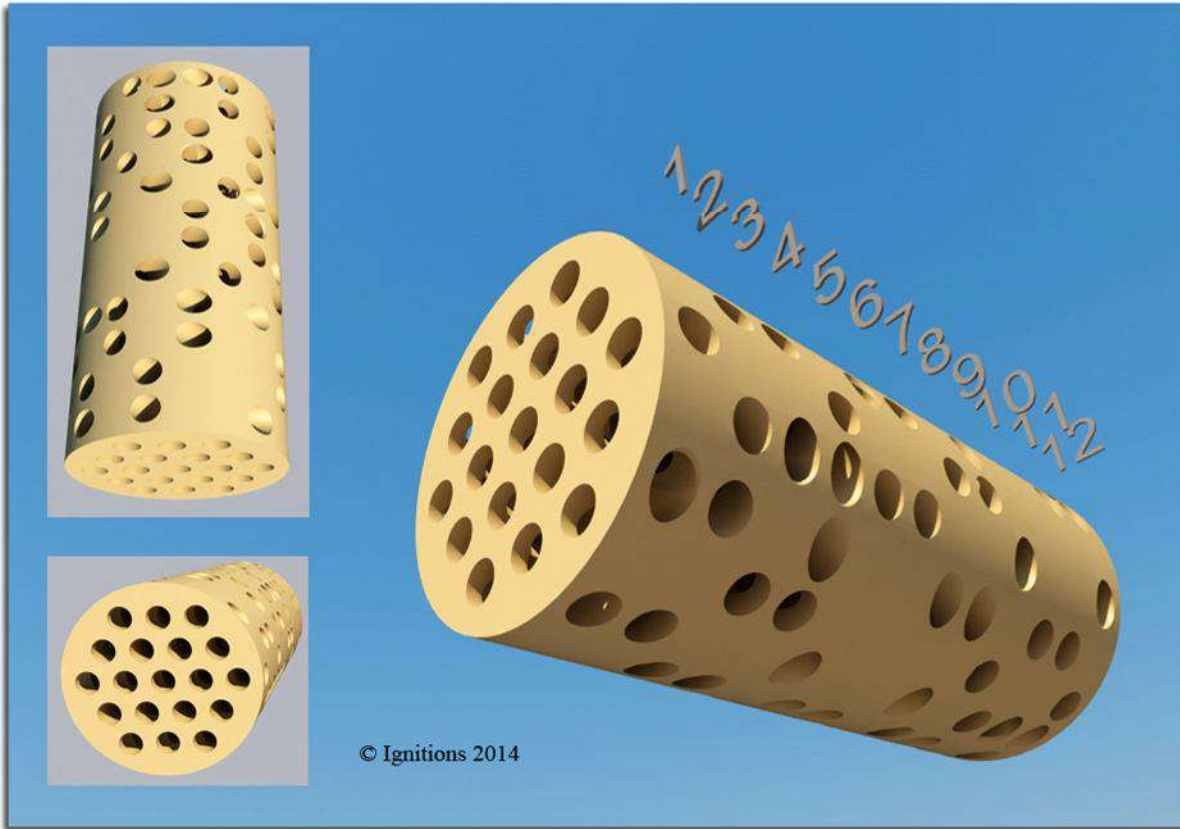

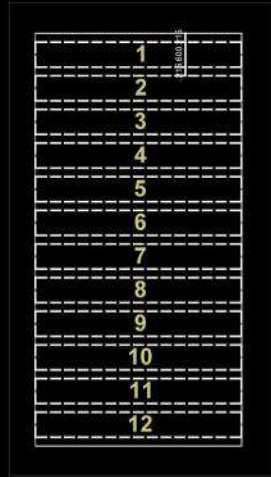
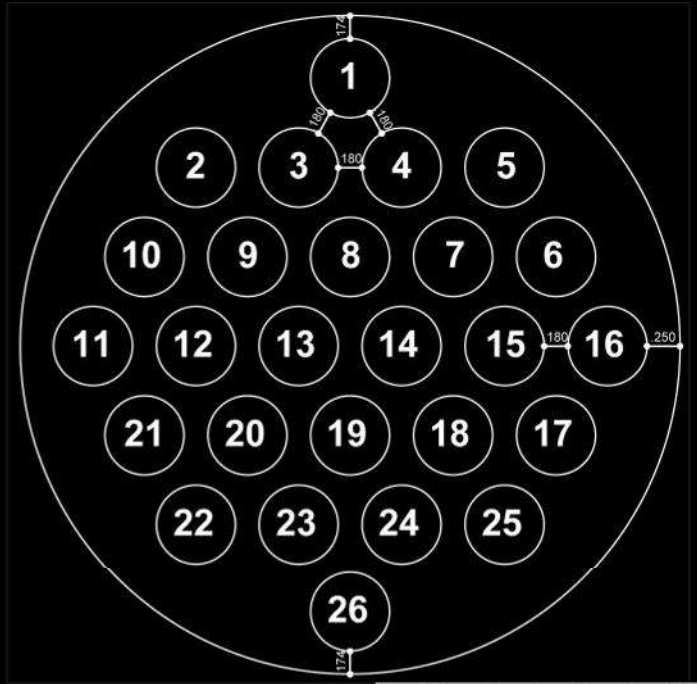
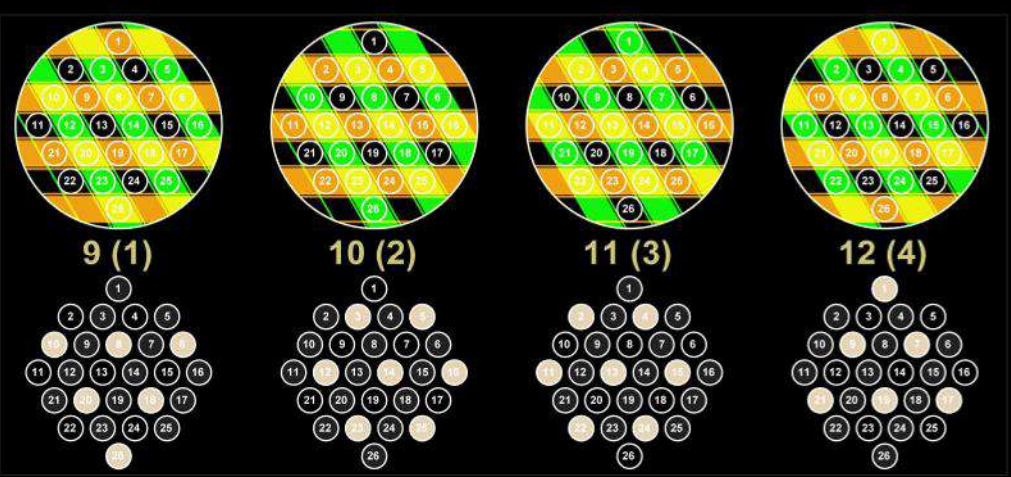
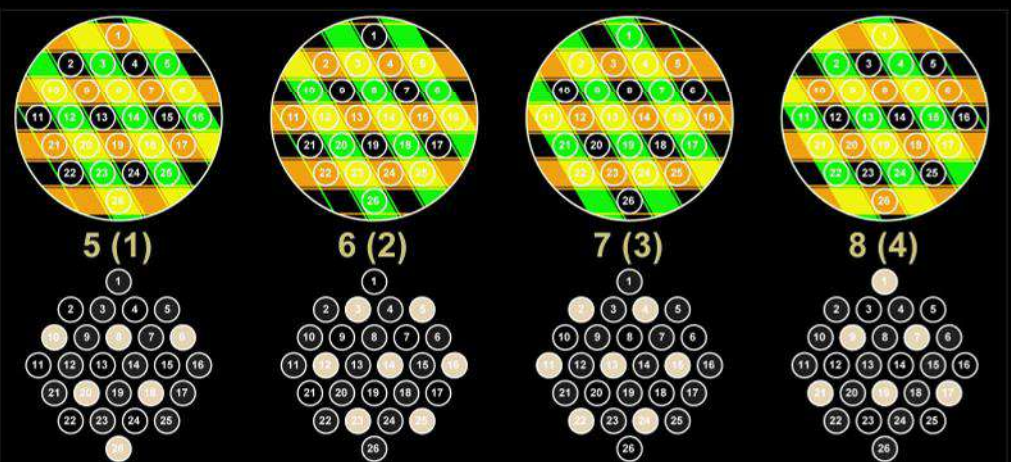
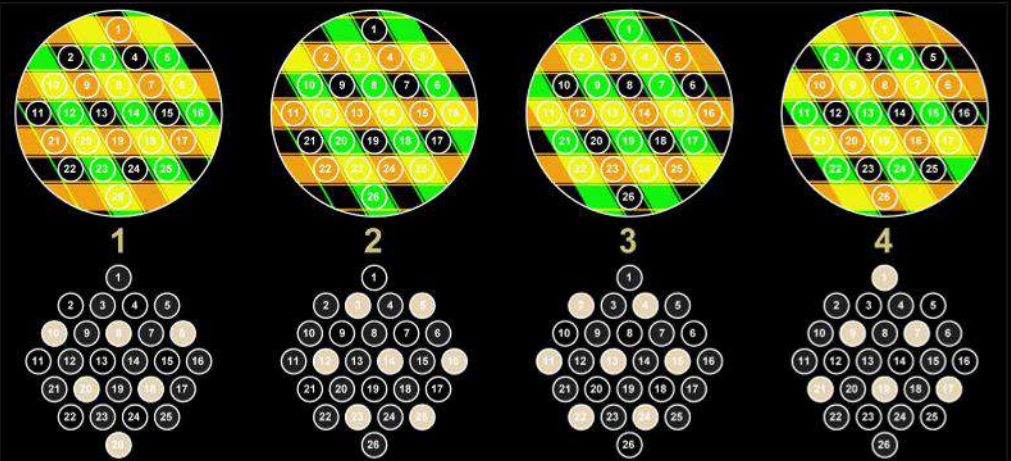

	1	2	3	4	1	2	3	4	1	2	3	4	
1	1	0	1	2	1	0	1	2	1	0	1	2	12
2	0	1	2	1	0	1	2	1	0	1	2	1	12
3	1	2	1	0	1	2	1	0	1	2	1	0	12
4	0	1	2	1	0	1	2	1	0	1	2	1	12
5	1	2	1	0	1	2	1	0	1	2	1	0	12
6	2	1	0	1	2	1	0	1	2	1	0	1	12
7	1	0	1	2	1	0	1	2	1	0	1	2	12
8	2	1	0	1	2	1	0	1	2	1	0	1	12
9	1	0	1	2	1	0	1	2	1	0	1	2	12
10	2	1	0	1	2	1	0	1	2	1	0	1	12
11	0	1	2	1	0	1	2	1	0	1	2	1	12
12	1	2	1	0	1	2	1	0	1	2	1	0	12
13	0	1	2	1	0	1	2	1	0	1	2	1	12
14	1	2	1	0	1	2	1	0	1	2	1	0	12
15	0	1	2	1	0	1	2	1	0	1	2	1	12
16	1	2	1	0	1	2	1	0	1	2	1	0	12
17	1	0	1	2	1	0	1	2	1	0	1	2	12
18	2	1	0	1	2	1	0	1	2	1	0	1	12
19	1	0	1	2	1	0	1	2	1	0	1	2	12
20	2	1	0	1	2	1	0	1	2	1	0	1	12
21	1	0	1	2	1	0	1	2	1	0	1	2	12
22	0	1	2	1	0	1	2	1	0	1	2	1	12
23	1	2	1	0	1	2	1	0	1	2	1	0	12
24	0	1	2	1	0	1	2	1	0	1	2	1	12
25	1	2	1	0	1	2	1	0	1	2	1	0	12
26	2	1	0	1	2	1	0	1	2	1	0	1	12
	25	27	27	25	25	27	27	25	25	27	27	25	

ΧΩΡΙΣ ΔΙΑΣΤΥΡΩΣΗ  
 2 ΔΡΟΜΩΝ ΔΙΑΣΤΥΡΩΣΗ  
 3 ΔΡΟΜΩΝ ΔΙΑΣΤΥΡΩΣΗ

26p\_min180(lim)\_12slice\_prop1



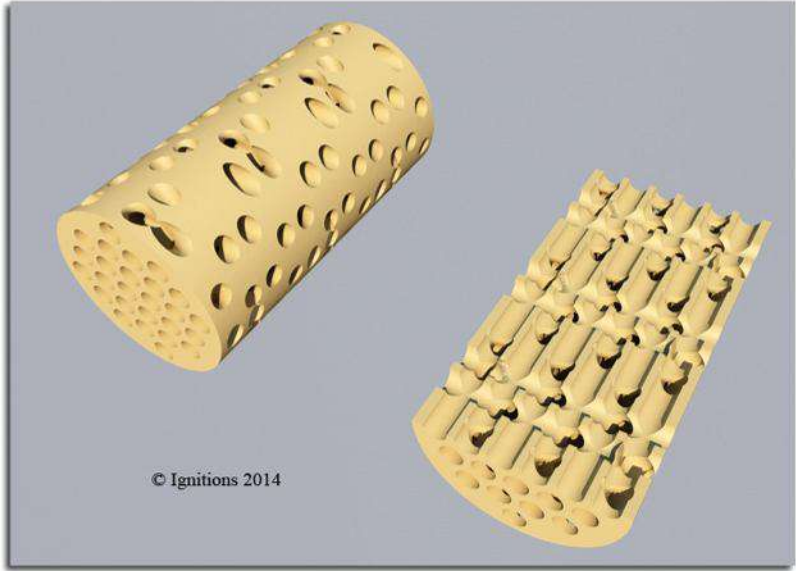
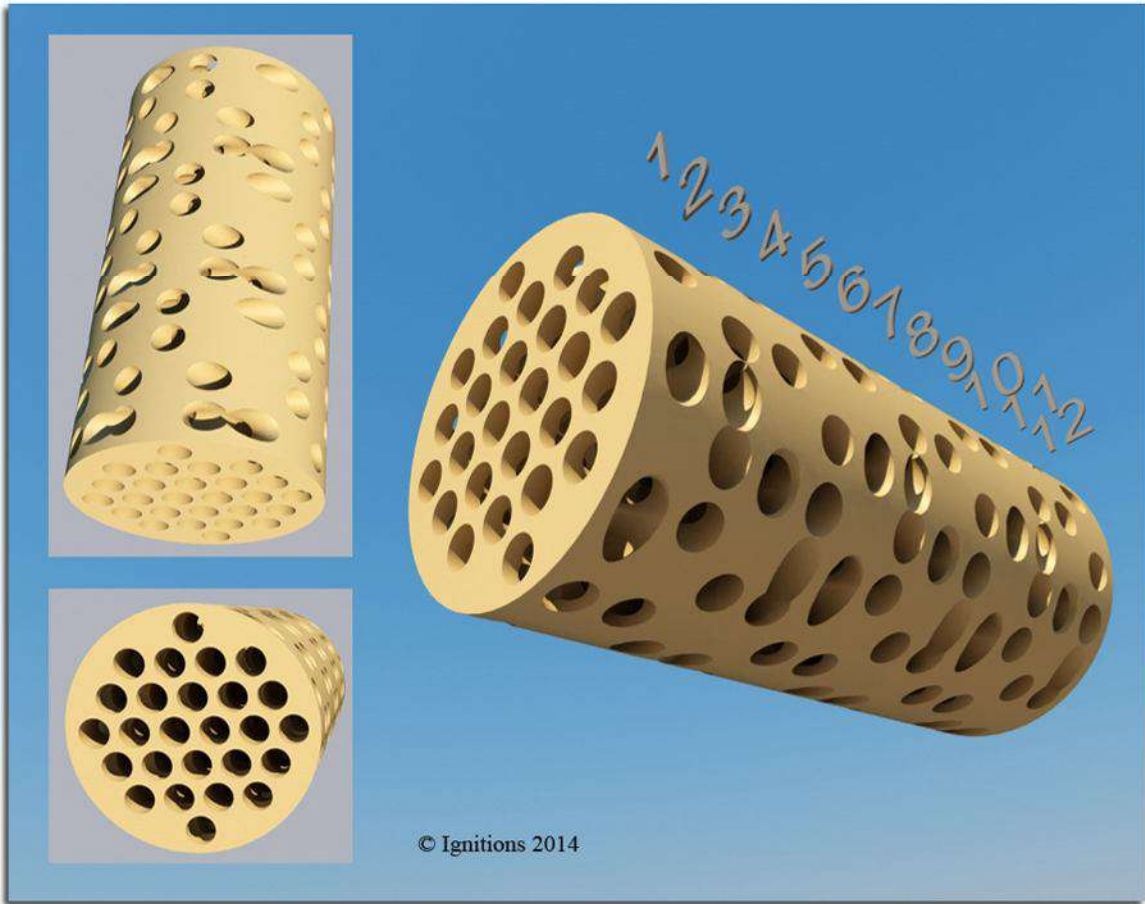



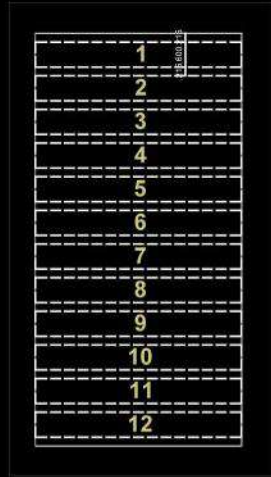
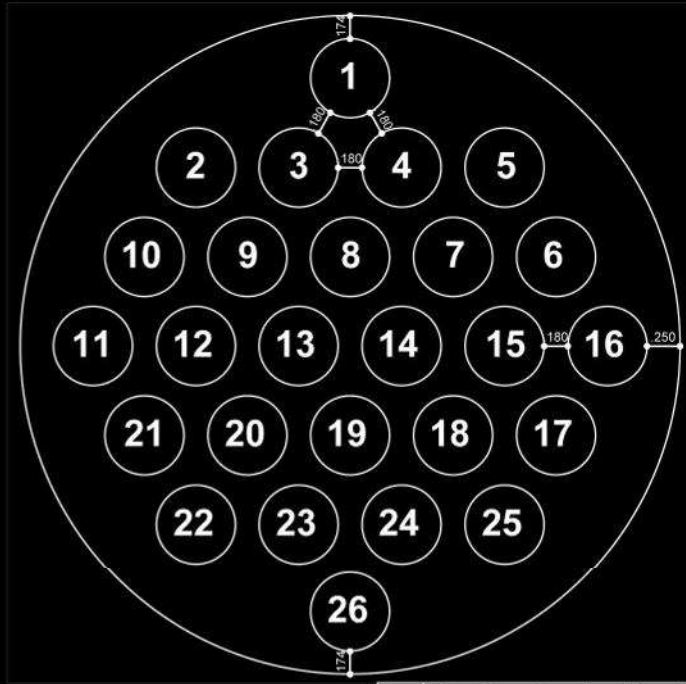
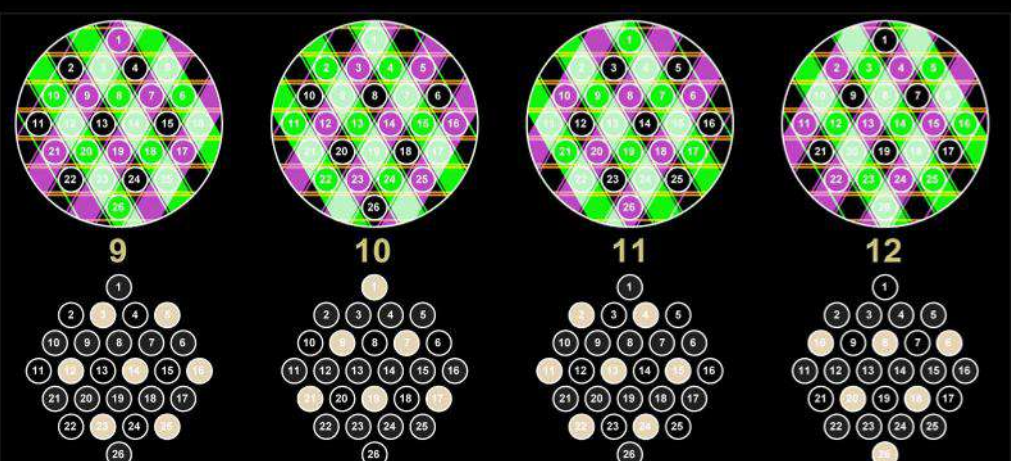
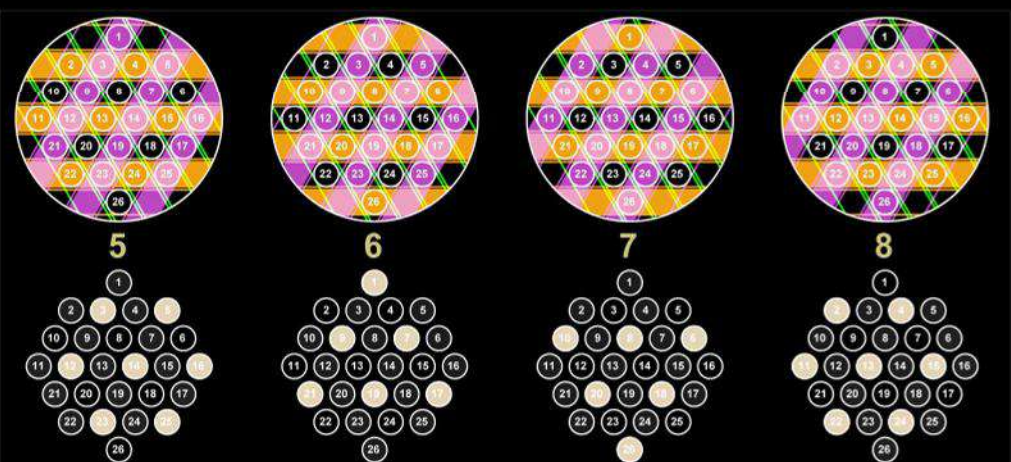
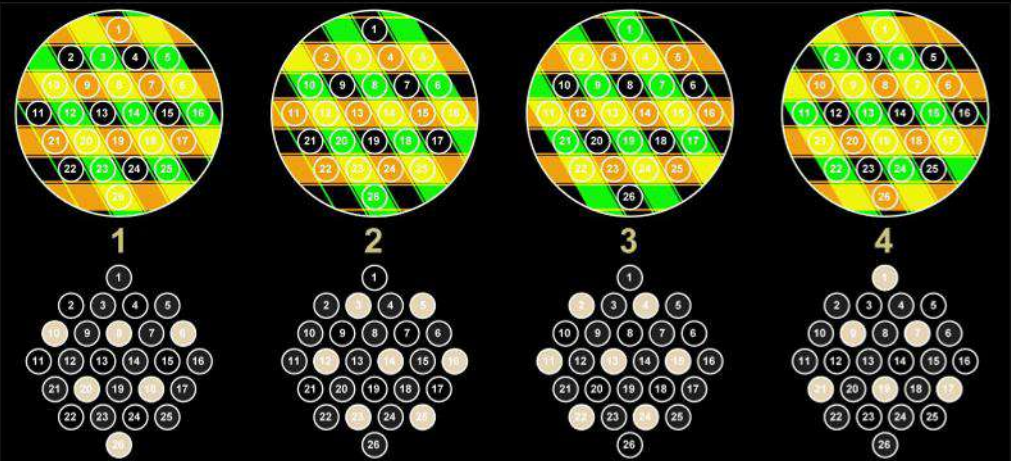

	1	2	3	4	5	6	7	8	9	10	11	12	
1	1	0	1	2	1	2	1	0	1	2	1	0	12
2	0	1	2	1	1	0	1	2	0	1	2	1	12
3	1	2	1	0	2	1	0	1	2	1	0	1	12
4	0	1	2	1	1	0	1	2	0	1	2	1	12
5	1	2	1	0	2	1	0	1	2	1	0	1	12
6	2	1	0	1	0	1	2	1	1	0	1	2	12
7	1	0	1	2	1	2	1	0	1	2	1	0	12
8	2	1	0	1	0	1	2	1	1	0	1	2	12
9	1	0	1	2	1	2	1	0	1	2	1	0	12
10	2	1	0	1	0	1	2	1	1	0	1	2	12
11	0	1	2	1	1	0	1	2	0	1	2	1	12
12	1	2	1	0	2	1	0	1	2	1	0	1	12
13	0	1	2	1	1	0	1	2	0	1	2	1	12
14	1	2	1	0	2	1	0	1	2	1	0	1	12
15	0	1	2	1	1	0	1	2	0	1	2	1	12
16	1	2	1	0	2	1	0	1	2	1	0	1	12
17	1	0	1	2	1	2	1	0	1	2	1	0	12
18	2	1	0	1	0	1	2	1	1	0	1	2	12
19	1	0	1	2	1	2	1	0	1	2	1	0	12
20	2	1	0	1	0	1	2	1	1	0	1	2	12
21	1	0	1	2	1	2	1	0	1	2	1	0	12
22	0	1	2	1	1	0	1	2	0	1	2	1	12
23	1	2	1	0	2	1	0	1	2	1	0	1	12
24	0	1	2	1	1	0	1	2	0	1	2	1	12
25	1	2	1	0	2	1	0	1	2	1	0	1	12
26	2	1	0	1	0	1	2	1	1	0	1	2	12
	25	27	27	25	27	25	25	27	26	26	26	26	

○ ΚΟΡΜΕ ΔΙΑΣΤΑΥΡΩΣΗ  
 ● 2 ΣΠΟΝΔΟΙ ΔΙΑΣΤΑΥΡΩΣΗ  
 ● 3 ΣΠΟΝΔΟΙ ΔΙΑΣΤΑΥΡΩΣΗ

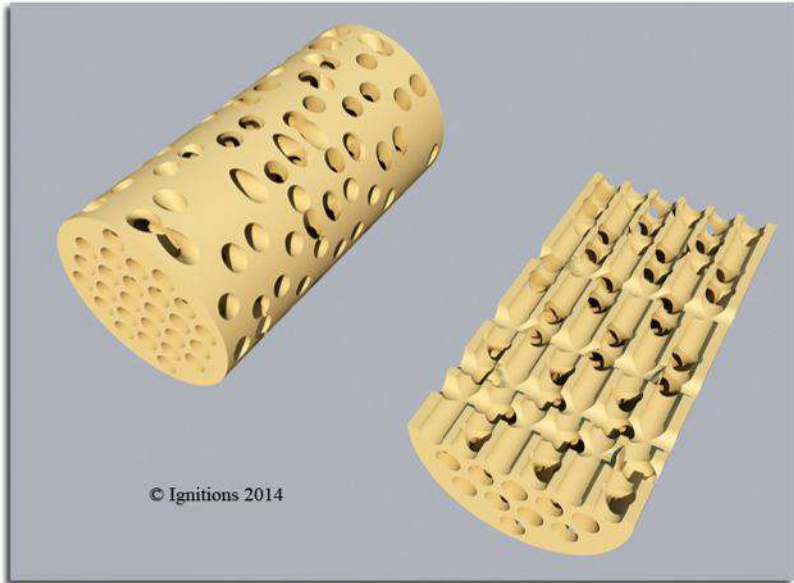
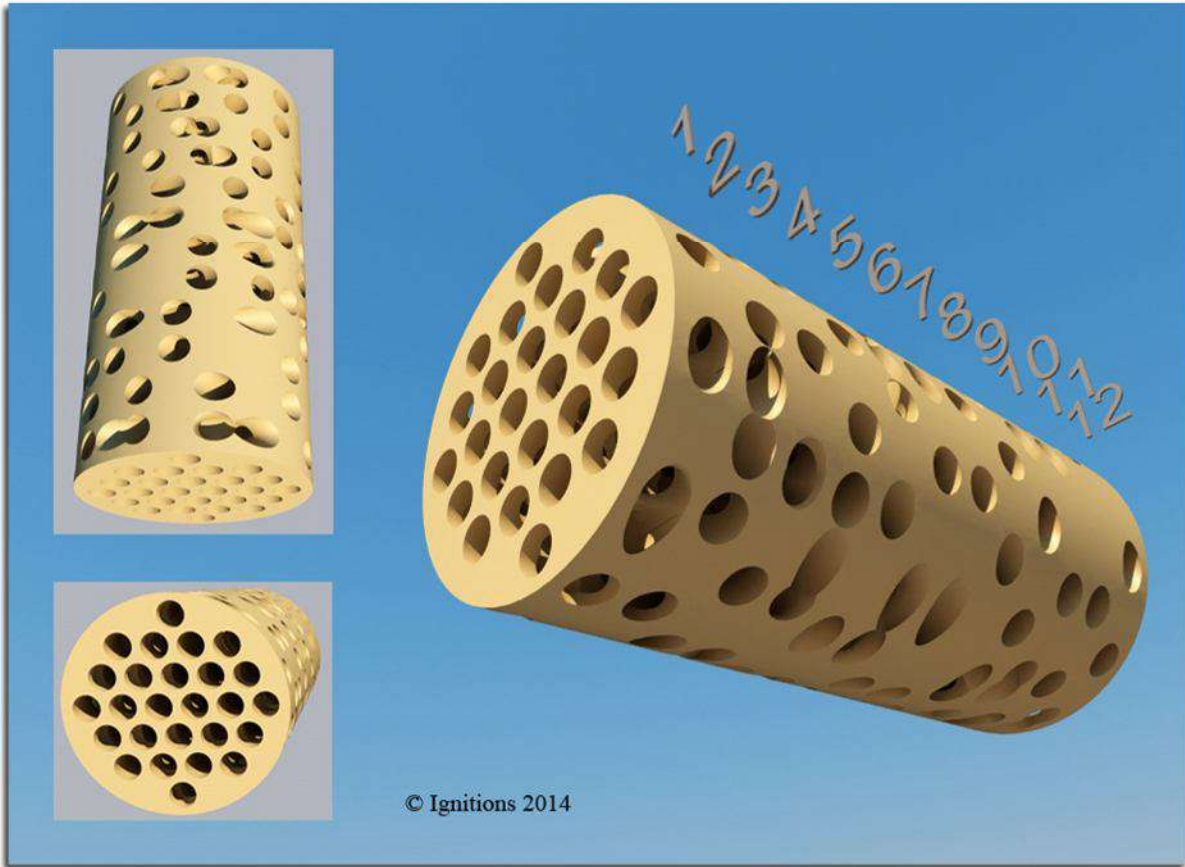



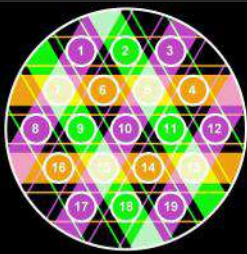

1

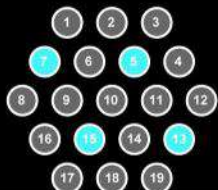

2

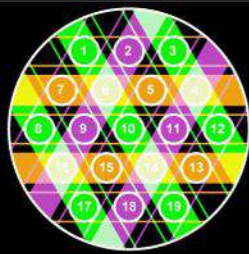
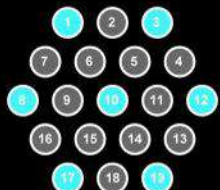

3

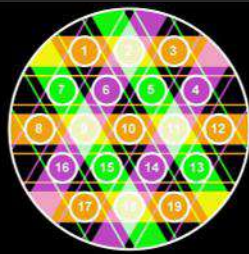
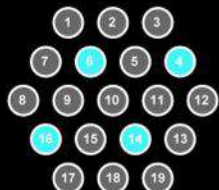

4

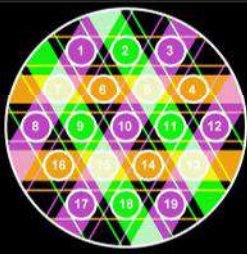
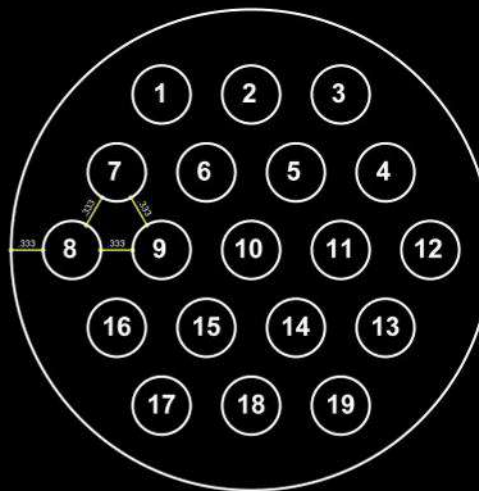
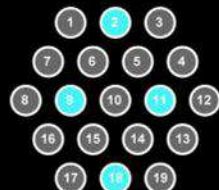

5(1)

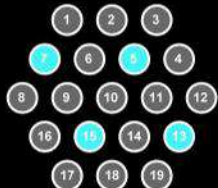

6(2)

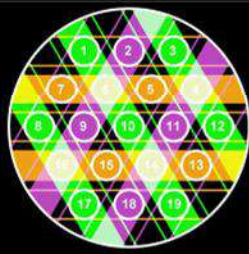
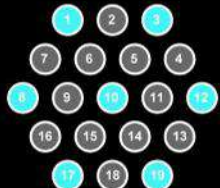

7(3)

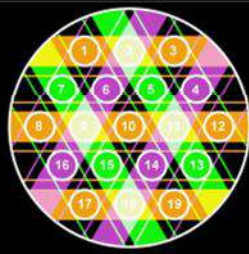
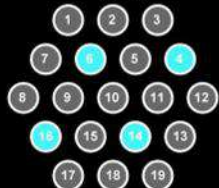

8(4)

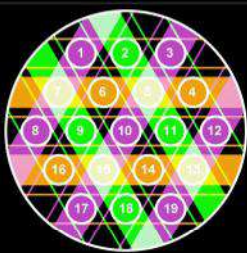
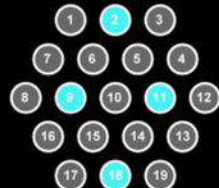

9(1)

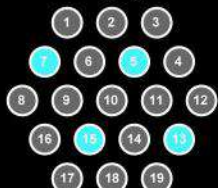

10(2)

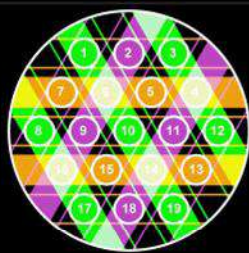
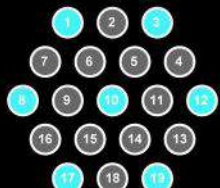

11(3)

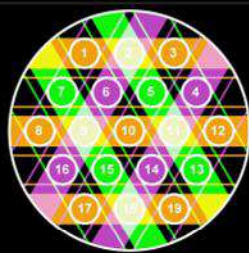
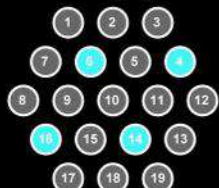

12(4)

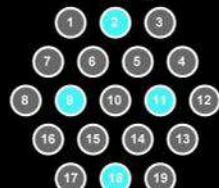

	1	2	3	4	5	6	7	8	9	10	11	12	
	1	2	3	4	1	2	3	4	1	2	3	4	
1	1	3	1	1	1	3	1	1	1	3	1	1	18
2	1	1	1	3	1	1	1	3	1	1	1	3	18
3	1	3	1	1	1	3	1	1	1	3	1	1	18
4	1	1	3	1	1	1	3	1	1	1	3	1	18
5	3	1	1	1	3	1	1	1	3	1	1	1	18
6	1	1	3	1	1	1	3	1	1	1	3	1	18
7	3	1	1	1	3	1	1	1	3	1	1	1	18
8	1	3	1	1	1	3	1	1	1	3	1	1	18
9	1	1	1	3	1	1	1	3	1	1	1	3	18
10	1	3	1	1	1	3	1	1	1	3	1	1	18
11	1	1	1	3	1	1	1	3	1	1	1	3	18
12	1	3	1	1	1	3	1	1	1	3	1	1	18
13	3	1	1	1	3	1	1	1	3	1	1	1	18
14	1	1	3	1	1	1	3	1	1	1	3	1	18
15	3	1	1	1	3	1	1	1	3	1	1	1	18
16	1	1	3	1	1	1	3	1	1	1	3	1	18
17	1	3	1	1	1	3	1	1	1	3	1	1	18
18	1	1	1	3	1	1	1	3	1	1	1	3	18
19	1	3	1	1	1	3	1	1	1	3	1	1	18
	27	33	27	27	27	33	27	27	27	33	27	27	342

- ΧΩΡΙΣ ΔΙΑΣΤΑΥΡΩΣΗ
- 2 ΔΡΟΜΩΝ ΔΙΑΣΤΑΥΡΩΣΗ
- 3 ΔΡΟΜΩΝ ΔΙΑΣΤΑΥΡΩΣΗ
- 4 ΔΡΟΜΩΝ ΔΙΑΣΤΑΥΡΩΣΗ

19p\_min180\_12slice\_triangle\_prop1

© Ignitions 2014



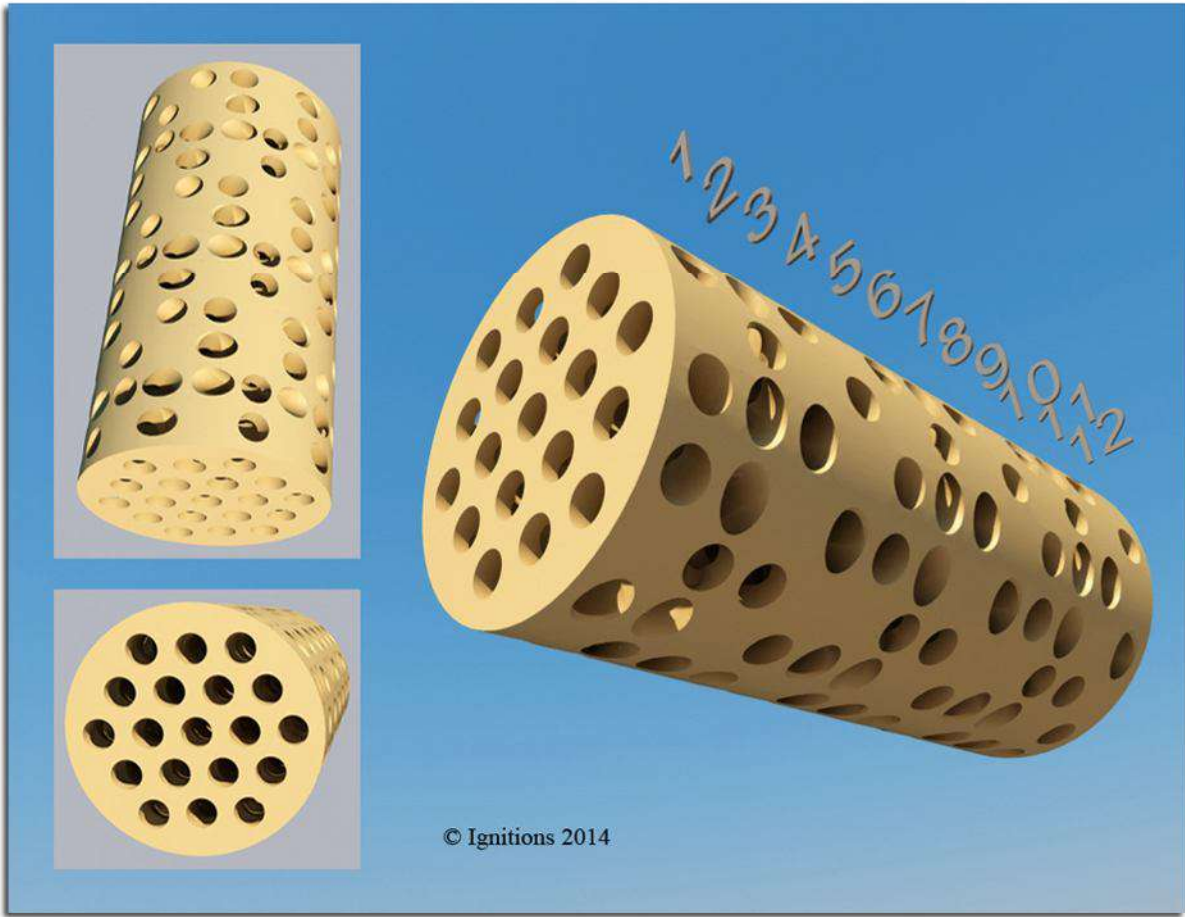



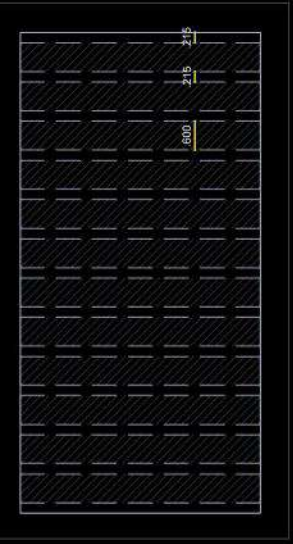
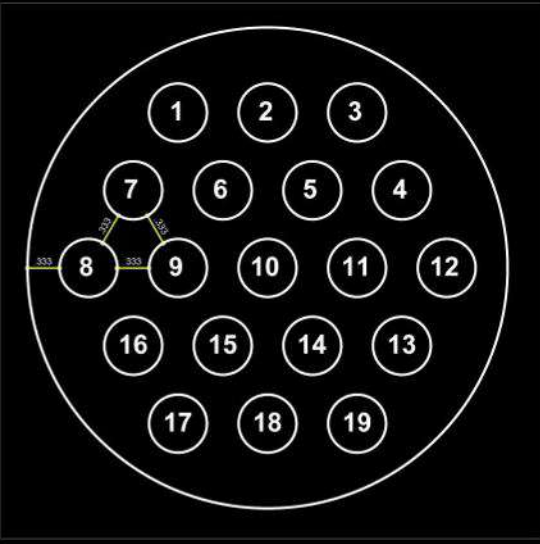
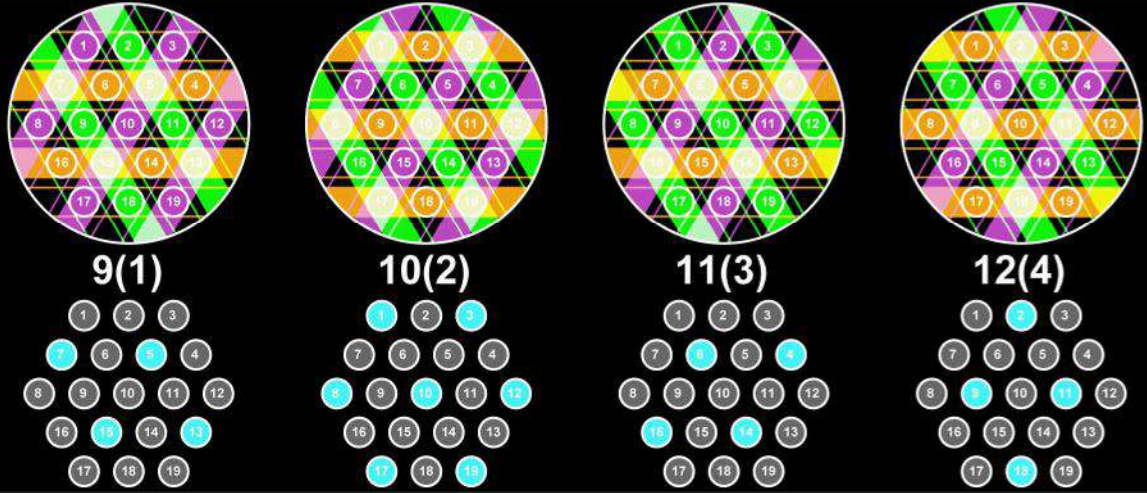
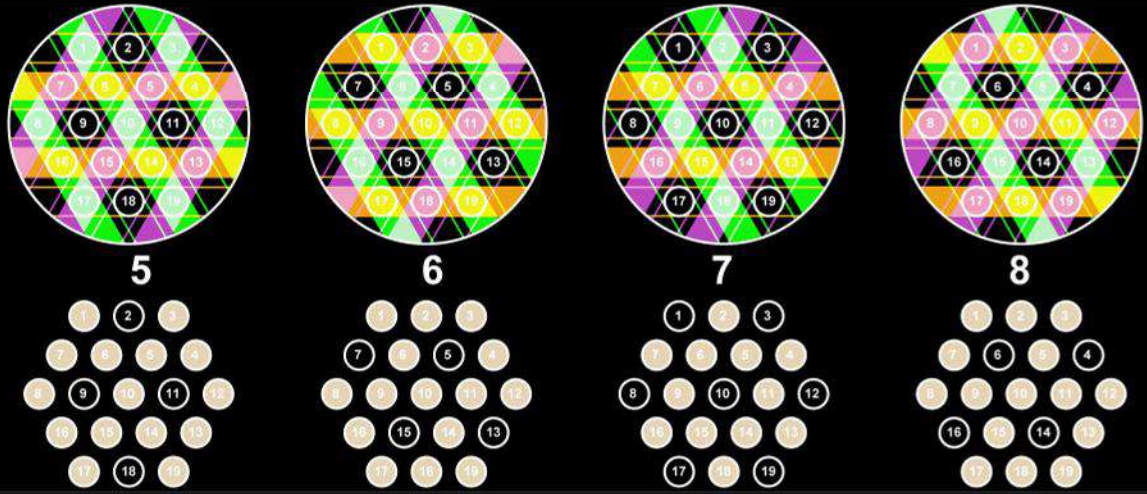
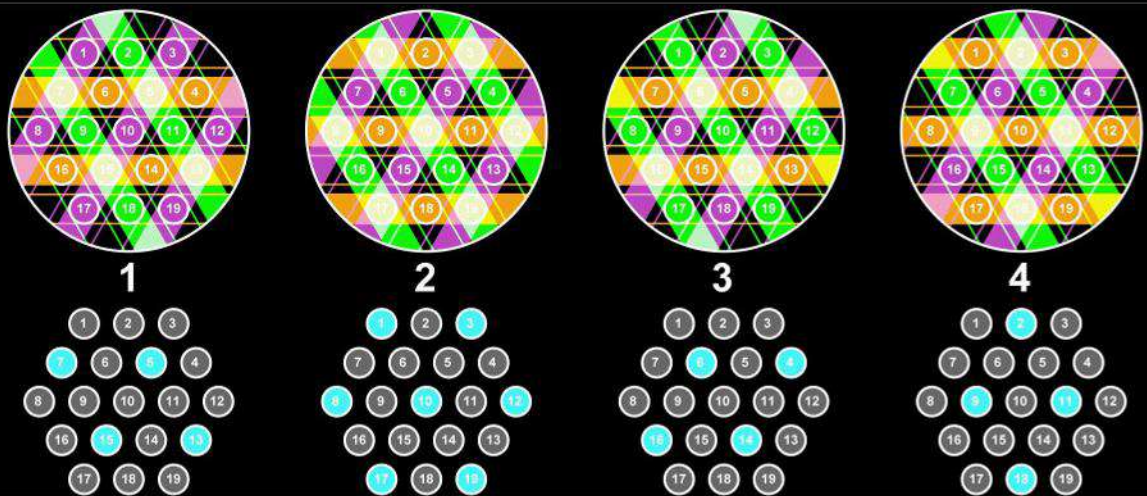

	1	2	3	4	5	6	7	8	9	10	11	12	
1	1												18
2	1	1											18
3	1		1										18
4	1			1									18
5		1			1								18
6		1	1			1							18
7			1				1						18
8				1				1					18
9					1				1				18
10						1				1			18
11							1				1		18
12								1				1	18
13									1				18
14										1			18
15											1		18
16												1	18
17													18
18													18
19													18
	27	33	27	27	30	30	24	30	27	33	27	27	342

- ΧΩΡΙΣ ΔΙΑΤΑΥΡΩΣΗ
- 2 ΔΡΟΜΩΝ ΔΙΑΤΑΥΡΩΣΗ
- 3 ΔΡΟΜΩΝ ΔΙΑΤΑΥΡΩΣΗ
- 4 ΔΡΟΜΩΝ ΔΙΑΤΑΥΡΩΣΗ



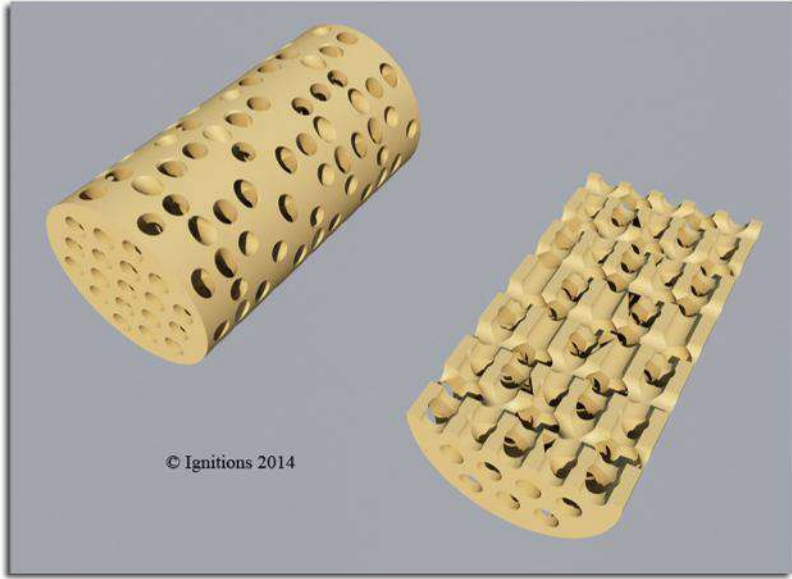
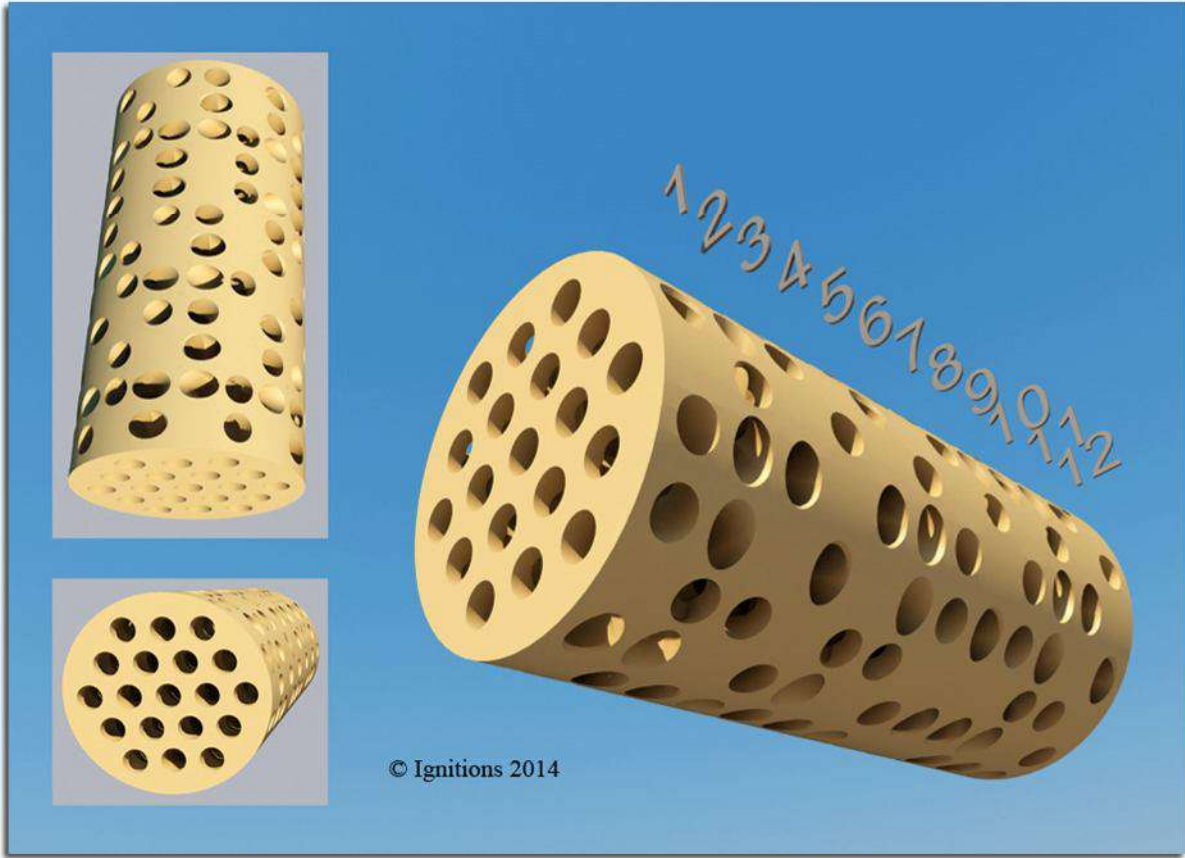





1(5)

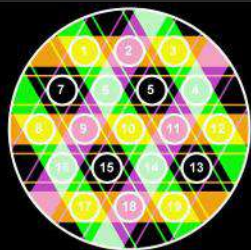
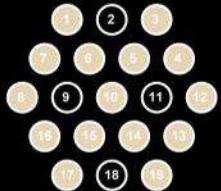

2(6)

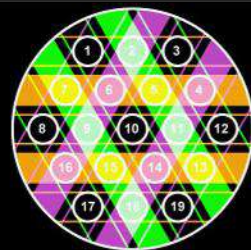
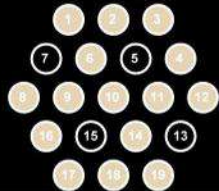

3(7)

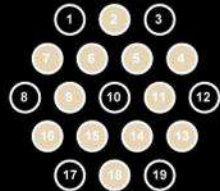

4(8)

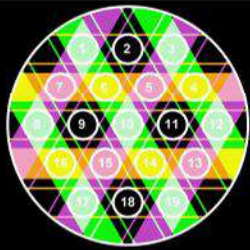
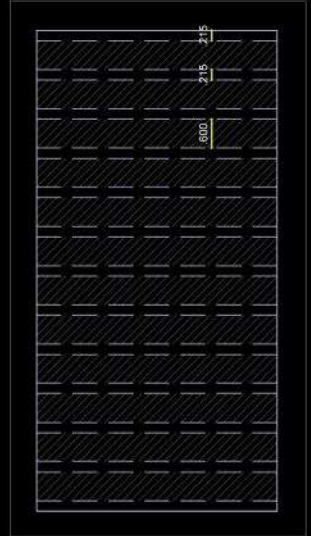
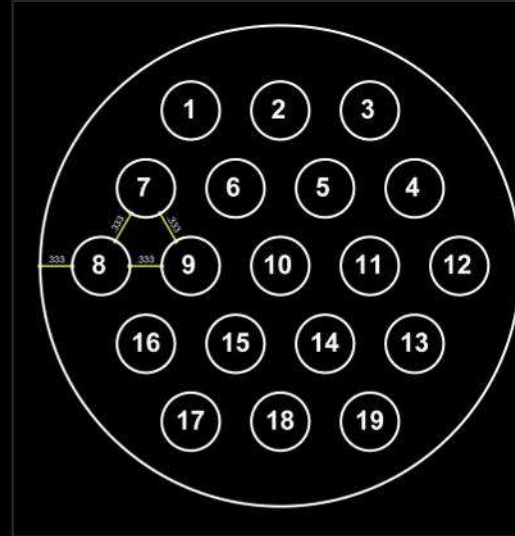
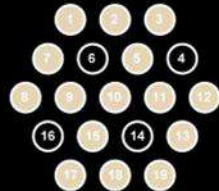

5

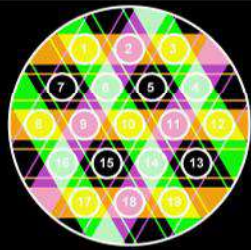
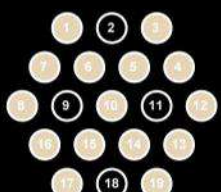

6

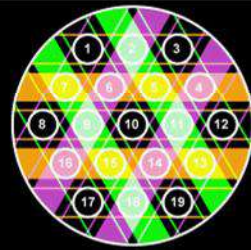
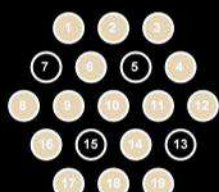

7

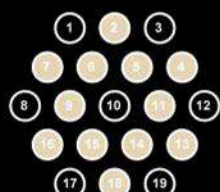

8



9(5)

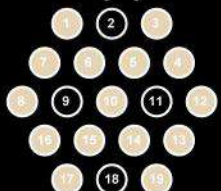

10(6)

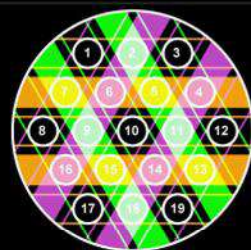
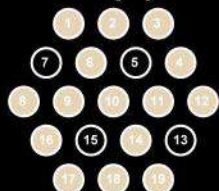

11(7)

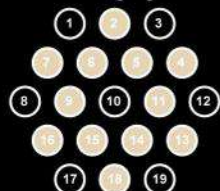

12(8)

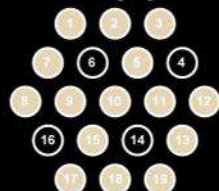

	1	2	3	4	5	6	7	8	9	10	11	12		
	1	2	3	4	1	2	3	4	1	2	3	4		
1		2	2	0	2	2	2	0	2	2	2	0	2	18
2	0		2	2	2	0	2	2	2	0	2	2	2	18
3	2	2		0	2	2	2	0	2	2	2	0	2	18
4	2	2	2		0	2	2	2	0	2	2	2	0	18
5	2	0	2	2		2	0	2	2	2	0	2	2	18
6	2	2	2	0	2		2	2	0	2	2	2	0	18
7	2	0	2	2	2	0		2	2	2	0	2	2	18
8	2	2	0	2	2	2	0		2	2	2	0	2	18
9	0	2	2	2	0	2	2	2		0	2	2	2	18
10	2	2	0	2	2	2	0	2	2		2	0	2	18
11	0	2	2	2	0	2	2	2	0	2		2	2	18
12	2	2	0	2	2	2	0	2	2	2	0		2	18
13	2	0	2	2	2	0	2	2	2	0	2	2		18
14	2	2	2	0	2	2	2	0	2	2	2	0		18
15	2	0	2	2	2	0	2	2	2	0	2	2		18
16	2	2	2	0	2	2	2	0	2	2	2	0		18
17	2	2	0	2	2	2	0	2	2	2	0	2		18
18	0	2	2	2	0	2	2	2	0	2	2	2		18
19	2	2	0	2	2	2	0	2	2	2	0	2		18
	30	30	24	30	30	30	24	30	30	30	24	30	342	

- ΧΩΡΙΣ ΔΙΑΤΑΞΙΣ
- 2 ΔΡΟΜΩΝ ΔΙΑΤΑΞΙΣ
- 3 ΔΡΟΜΩΝ ΔΙΑΤΑΞΙΣ
- 4 ΔΡΟΜΩΝ ΔΙΑΤΑΞΙΣ

19p\_min180\_12slice\_triangle\_prop3



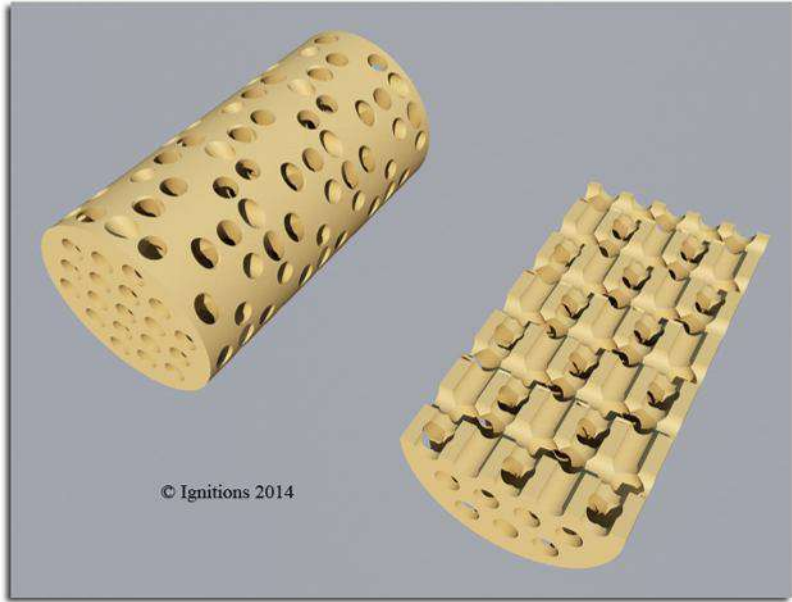
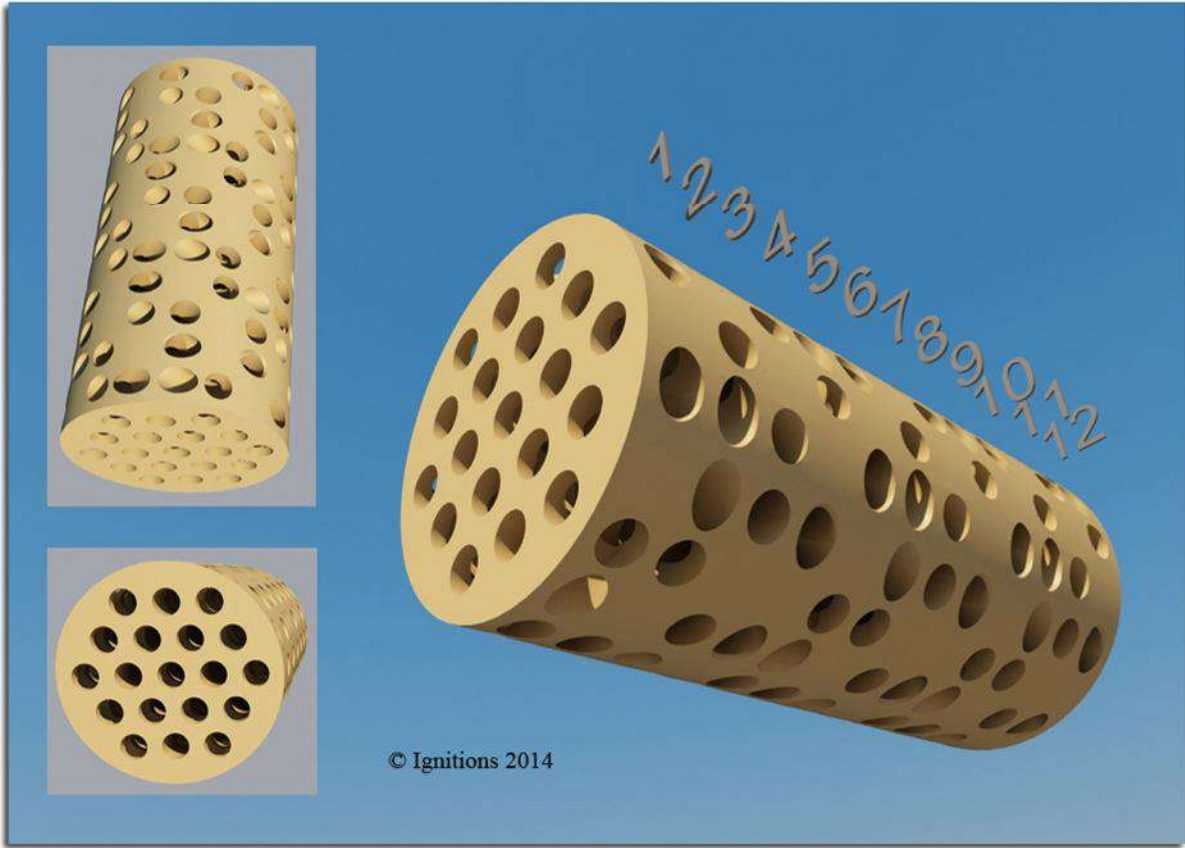

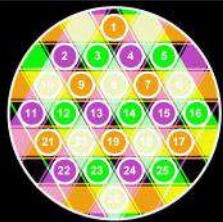

1

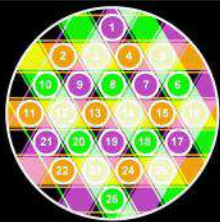

2

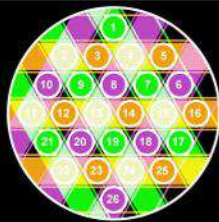

3

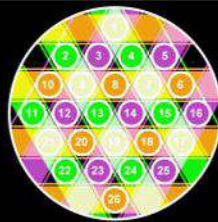
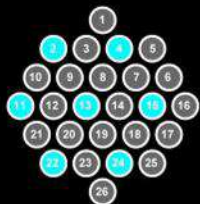

4

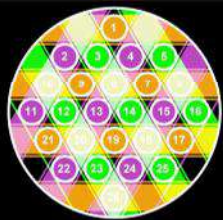

5 (1)

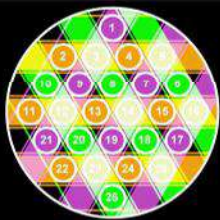

6 (2)

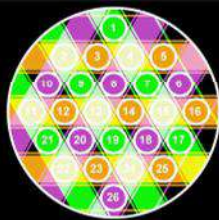

7 (3)

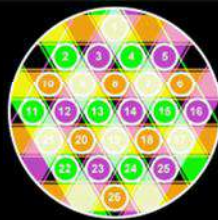
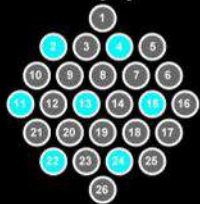

8 (4)



9 (1)

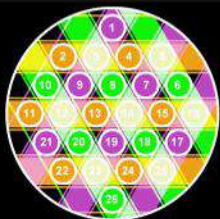

10 (2)

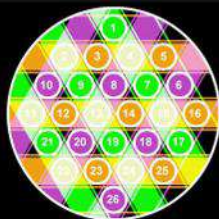

11 (3)



12 (4)

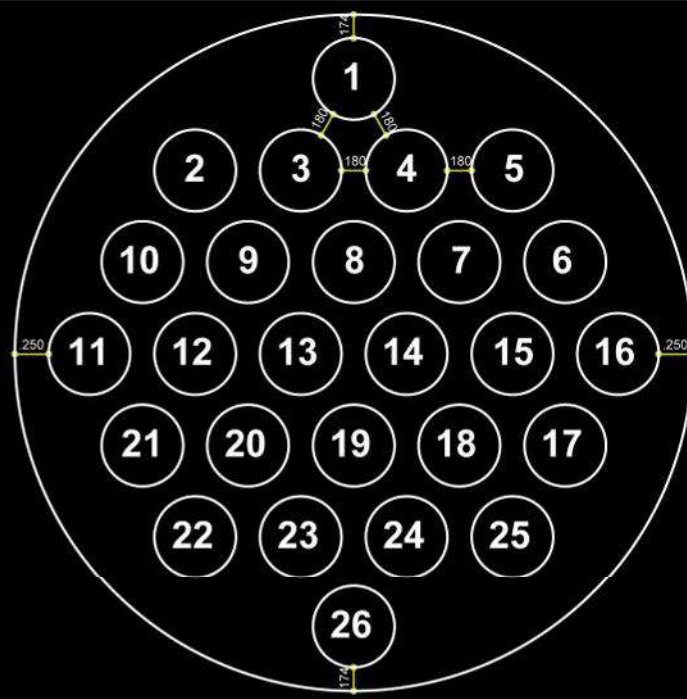
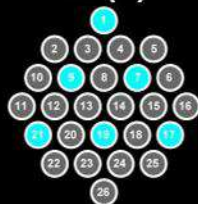

	1	2	3	4	5	6	7	8	9	10	11	12	
1	1	2	3	4	5	6	7	8	9	10	11	12	18
2	1	1	3	1	1	1	3	1	1	1	3	1	18
3	1	3	1	1	1	3	1	1	1	3	1	1	18
4	1	1	3	1	1	1	3	1	1	1	3	1	18
5	1	3	1	1	1	3	1	1	1	3	1	1	18
6	3	1	1	1	3	1	1	1	3	1	1	1	18
7	1	1	1	3	1	1	1	3	1	1	1	3	18
8	3	1	1	1	3	1	1	1	3	1	1	1	18
9	1	1	1	3	1	1	1	3	1	1	1	3	18
10	3	1	1	1	3	1	1	1	3	1	1	1	18
11	1	1	3	1	1	1	3	1	1	1	3	1	18
12	1	3	1	1	1	3	1	1	1	3	1	1	18
13	1	1	3	1	1	1	3	1	1	1	3	1	18
14	1	3	1	1	1	3	1	1	1	3	1	1	18
15	1	1	3	1	1	1	3	1	1	1	3	1	18
16	1	3	1	1	1	3	1	1	1	3	1	1	18
17	1	1	1	3	1	1	1	3	1	1	1	3	18
18	3	1	1	1	3	1	1	1	3	1	1	1	18
19	1	1	1	3	1	1	1	3	1	1	1	3	18
20	3	1	1	1	3	1	1	1	3	1	1	1	18
21	1	1	1	3	1	1	1	3	1	1	1	3	18
22	1	1	3	1	1	1	3	1	1	1	3	1	18
23	1	3	1	1	1	3	1	1	1	3	1	1	18
24	1	1	3	1	1	1	3	1	1	1	3	1	18
25	1	3	1	1	1	3	1	1	1	3	1	1	18
26	3	1	1	1	3	1	1	1	3	1	1	1	18
	38	40	40	38	40	40	38	40	38	40	40	38	468

26p\_min180(lim)\_12s\_triangle\_prop1





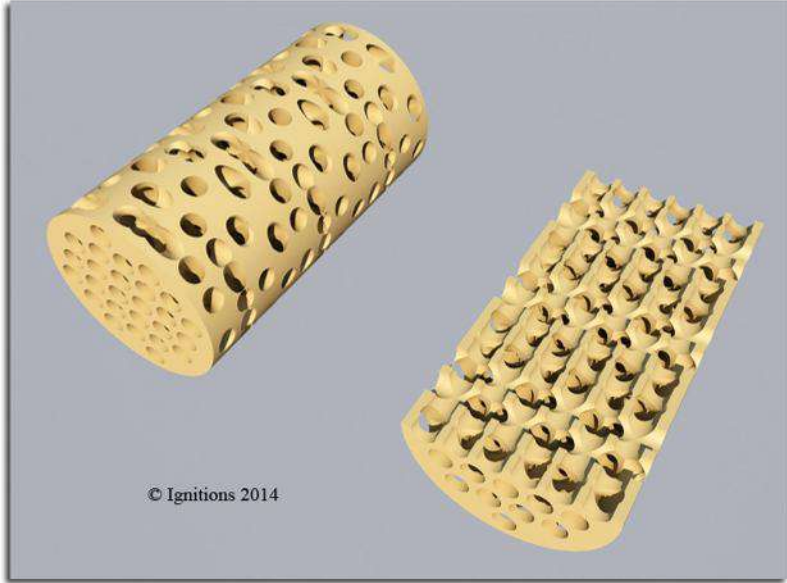

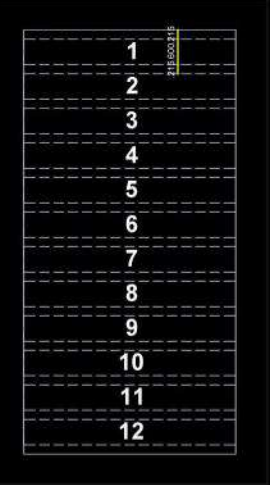
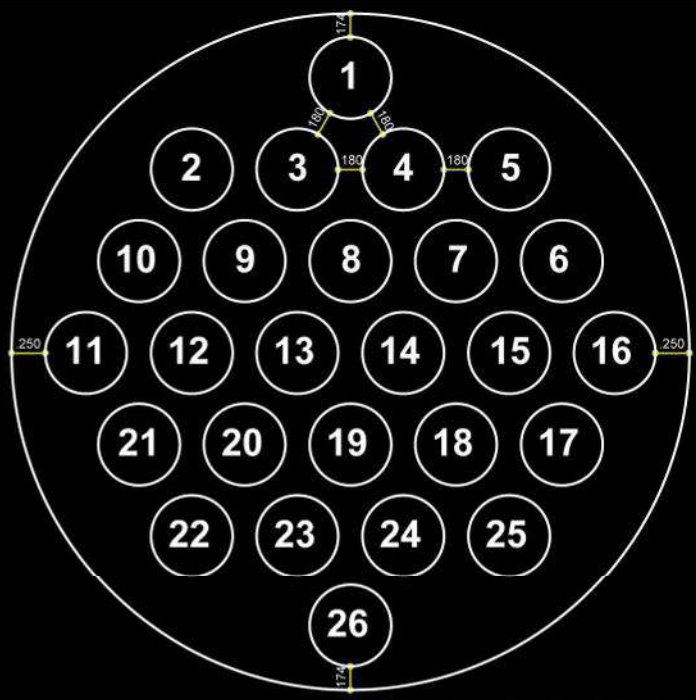
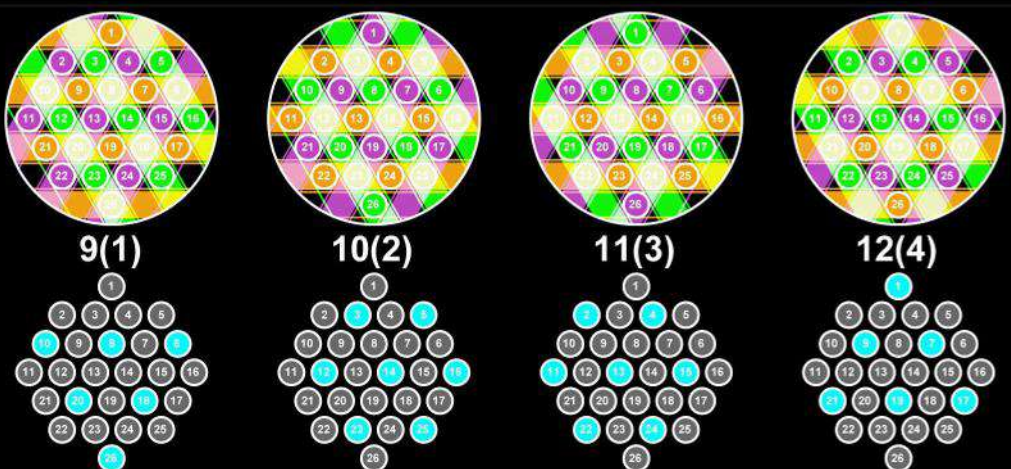
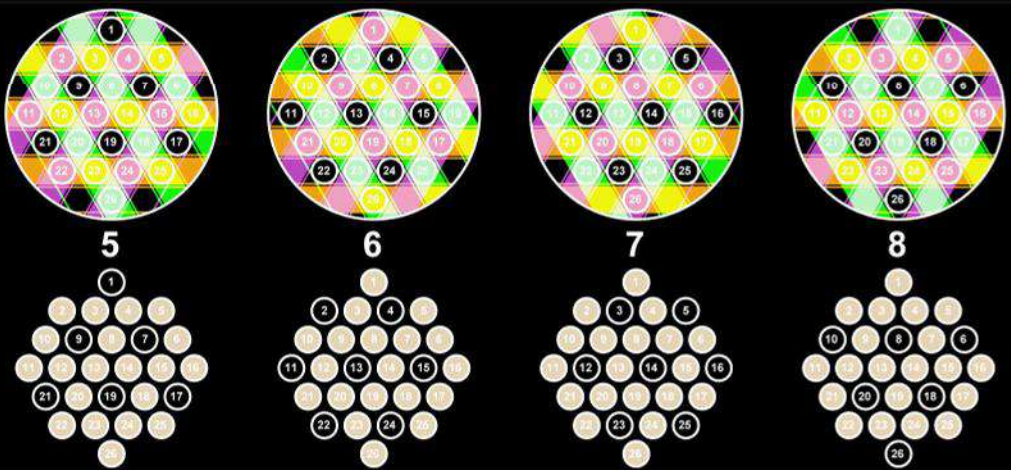
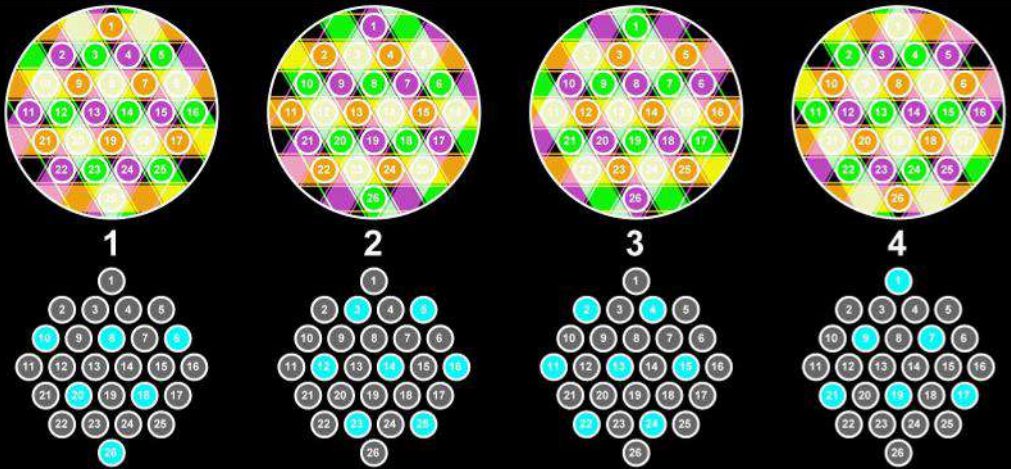

○ ΧΩΡΙΣ ΔΙΑΣΤΑΣΕΙΣ  
 ● 2 ΔΡΟΜΩΝ ΔΙΑΣΤΑΣΕΙΣ  
 ● 3 ΔΡΟΜΩΝ ΔΙΑΣΤΑΣΕΙΣ  
 ● 4 ΔΡΟΜΩΝ ΔΙΑΣΤΑΣΕΙΣ

	1	2	3	4	5	6	7	8	9	10	11	12	
1	1	1	1	3	0	2	2	2	1	1	1	3	18
2	1	1	3	1	2	0	2	2	1	1	3	1	18
3	1	3	1	1	2	2	0	2	1	3	1	1	18
4	1	1	3	1	2	0	2	2	1	1	3	1	18
5	1	3	1	1	2	2	0	2	1	3	1	1	18
6	3	1	1	1	2	2	2	0	3	1	1	1	18
7	1	1	1	3	0	2	2	2	1	1	1	3	18
8	3	1	1	1	2	2	2	0	3	1	1	1	18
9	1	1	1	3	0	2	2	2	1	1	1	3	18
10	3	1	1	1	2	2	2	0	3	1	1	1	18
11	1	1	3	1	2	0	2	2	1	1	3	1	18
12	1	3	1	1	2	2	0	2	1	3	1	1	18
13	1	1	3	1	2	0	2	2	1	1	3	1	18
14	1	3	1	1	2	2	0	2	1	3	1	1	18
15	1	1	3	1	2	0	2	2	1	1	3	1	18
16	1	3	1	1	2	2	0	2	1	3	1	1	18
17	1	1	1	3	0	2	2	2	1	1	1	3	18
18	3	1	1	1	2	2	2	0	3	1	1	1	18
19	1	1	1	3	0	2	2	2	1	1	1	3	18
20	3	1	1	1	2	2	0	3	1	1	1	1	18
21	1	1	1	3	0	2	2	2	1	1	1	3	18
22	1	1	3	1	2	0	2	2	1	1	3	1	18
23	1	3	1	1	2	2	0	2	1	3	1	1	18
24	1	1	3	1	2	0	2	2	1	1	3	1	18
25	1	3	1	1	2	2	0	2	1	3	1	1	18
26	3	1	1	1	2	2	2	0	3	1	1	1	18
	38	40	40	38	40	38	38	40	38	40	40	38	468

26p\_min180(lim)\_12s\_triangle\_prop2



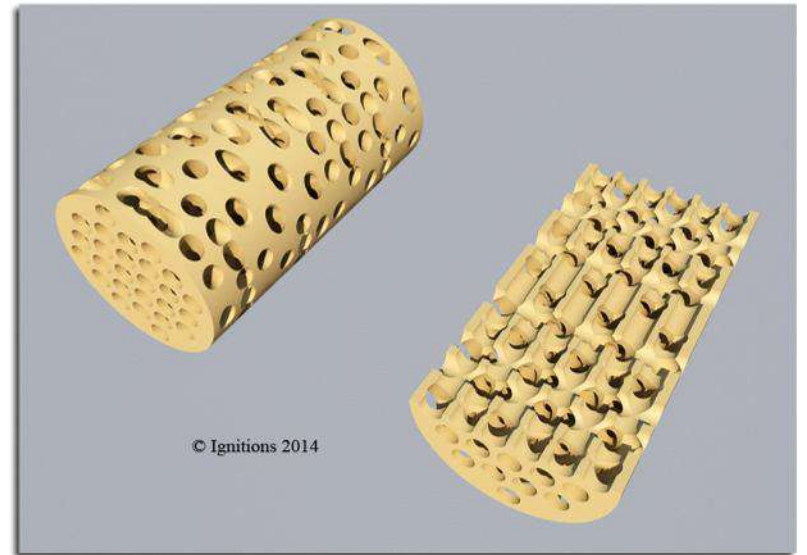
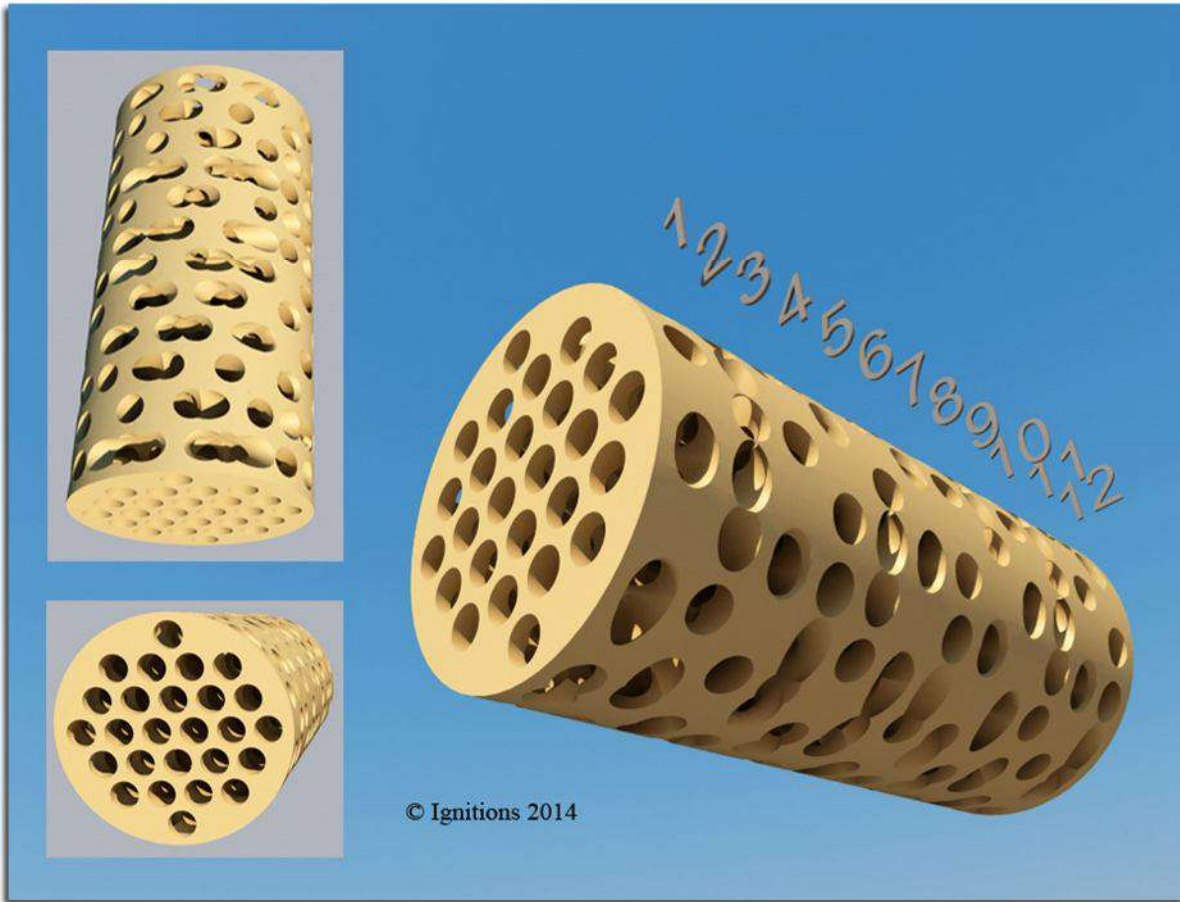



1(5)

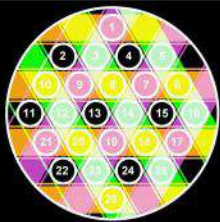

2(6)

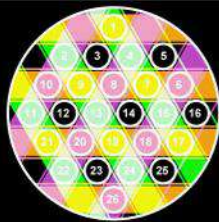
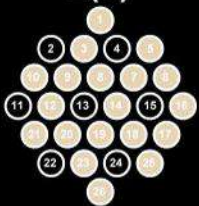

3(7)

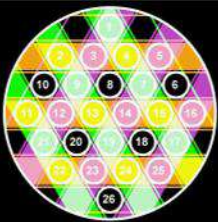
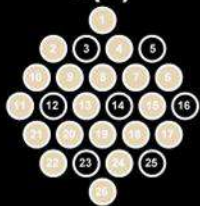

4(8)

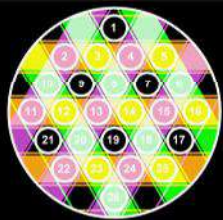
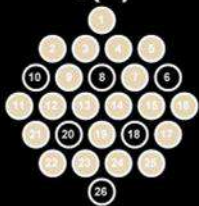

5

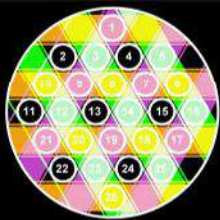
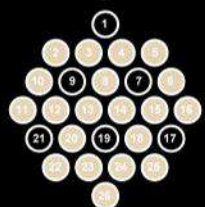

6

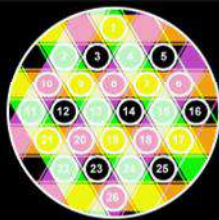
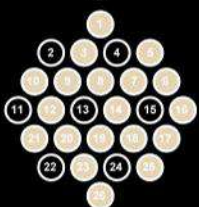

7

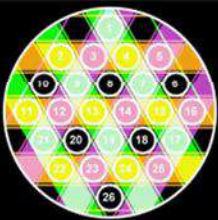
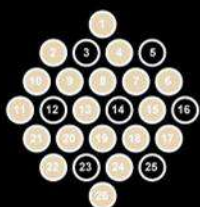

8

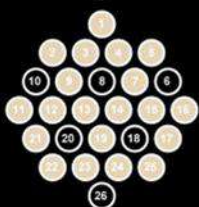

9(5)

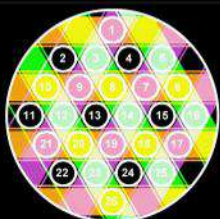

10(6)



11(7)

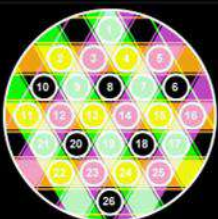

12(8)

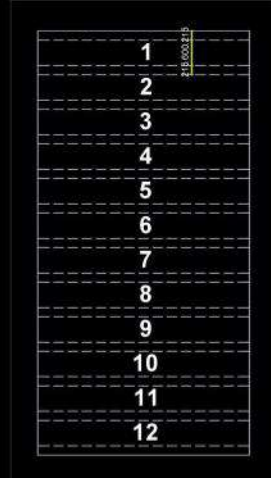
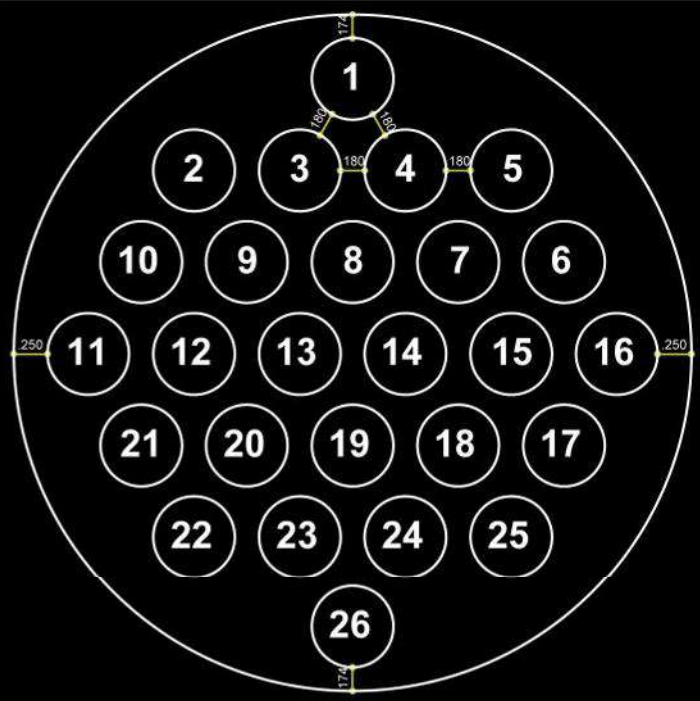
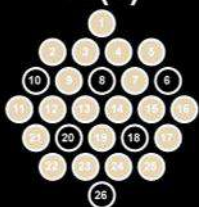

	1	2	3	4	5	6	7	8	9	10	11	12	
1	5	6	7	8	5	5	7	8	5	6	7	8	
1	1	1	1	3	0	2	2	2	1	1	1	3	18
2	1	1	3	1	2	0	2	2	1	1	3	1	18
3	1	3	1	1	2	2	0	2	1	3	1	1	18
4	1	1	3	1	2	0	2	2	1	1	3	1	18
5	1	3	1	1	2	2	0	2	1	3	1	1	18
6	3	1	1	1	2	2	0	3	1	1	1	3	18
7	1	1	1	3	0	2	2	2	1	1	1	3	18
8	3	1	1	1	2	2	0	3	1	1	1	3	18
9	1	1	1	3	0	2	2	2	1	1	1	3	18
10	3	1	1	1	2	2	0	3	1	1	1	3	18
11	1	1	3	1	2	0	2	2	1	1	3	1	18
12	1	3	1	1	2	2	0	2	1	3	1	1	18
13	1	1	3	1	2	0	2	2	1	1	3	1	18
14	1	3	1	1	2	2	0	2	1	3	1	1	18
15	1	1	3	1	2	0	2	2	1	1	3	1	18
16	1	3	1	1	2	2	0	2	1	3	1	1	18
17	1	1	1	3	0	2	2	2	1	1	1	3	18
18	3	1	1	1	2	2	0	3	1	1	1	3	18
19	1	1	1	3	0	2	2	2	1	1	1	3	18
20	3	1	1	1	2	2	0	3	1	1	1	3	18
21	1	1	1	3	0	2	2	2	1	1	1	3	18
22	1	1	3	1	2	0	2	2	1	1	3	1	18
23	1	3	1	1	2	2	0	2	1	3	1	1	18
24	1	1	3	1	2	0	2	2	1	1	3	1	18
25	1	3	1	1	2	2	0	2	1	3	1	1	18
26	3	1	1	1	2	2	0	3	1	1	1	3	18
	38	40	40	38	40	38	38	40	38	40	40	38	468

26p\_min180(lim)\_12s\_triangle\_prop3



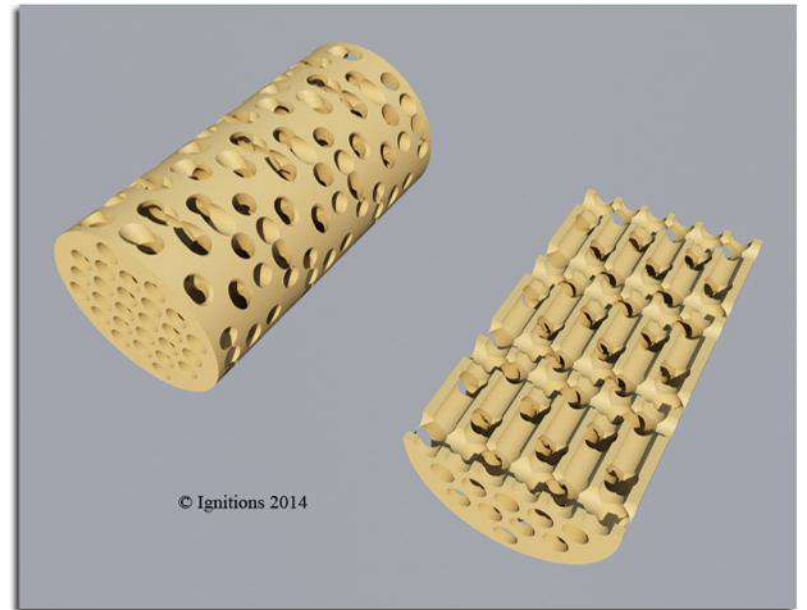
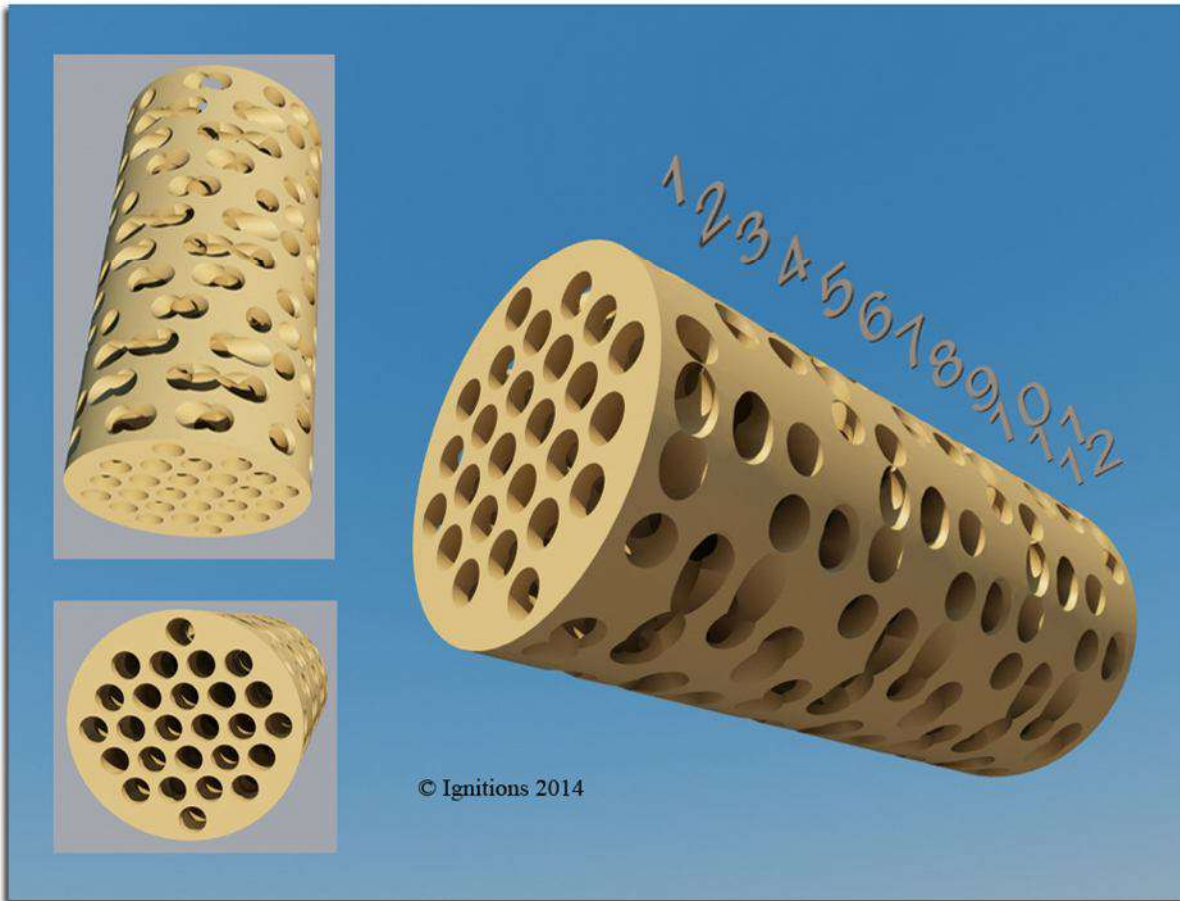

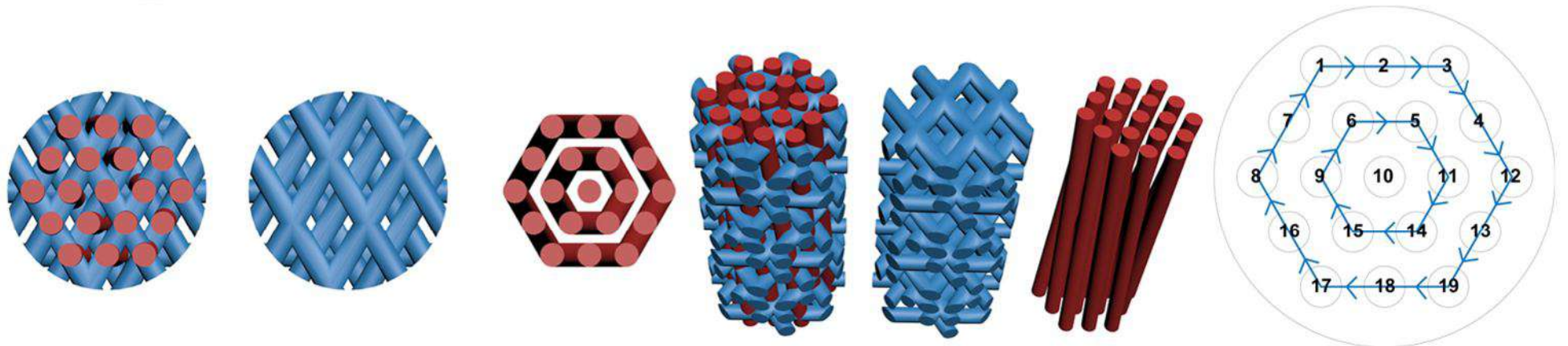
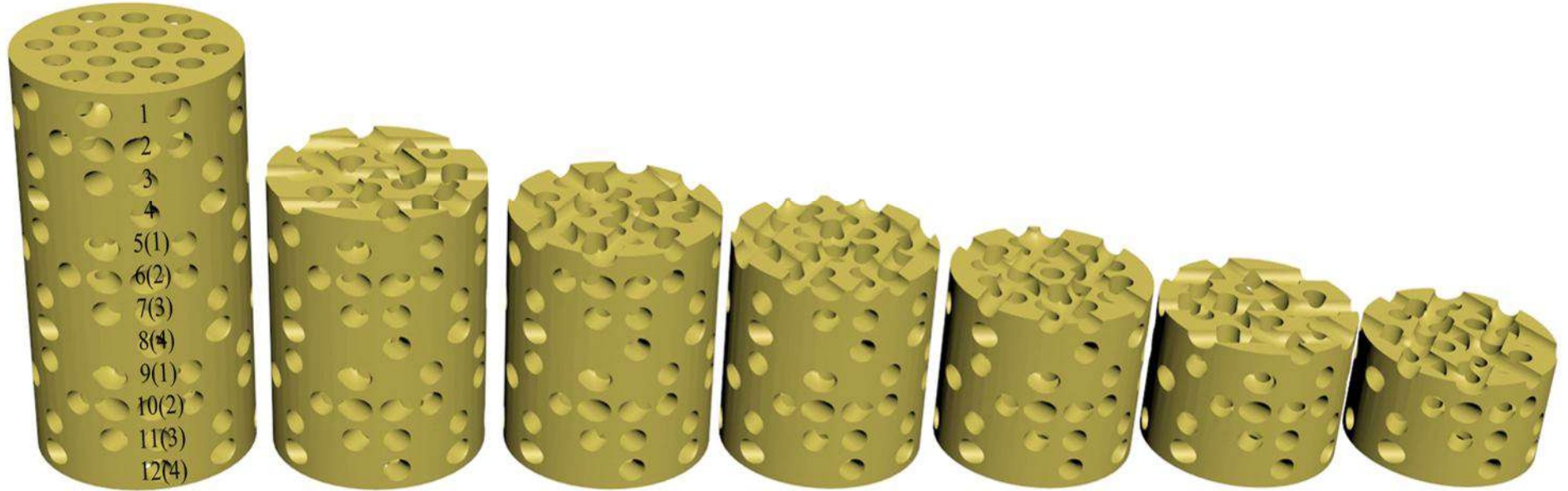
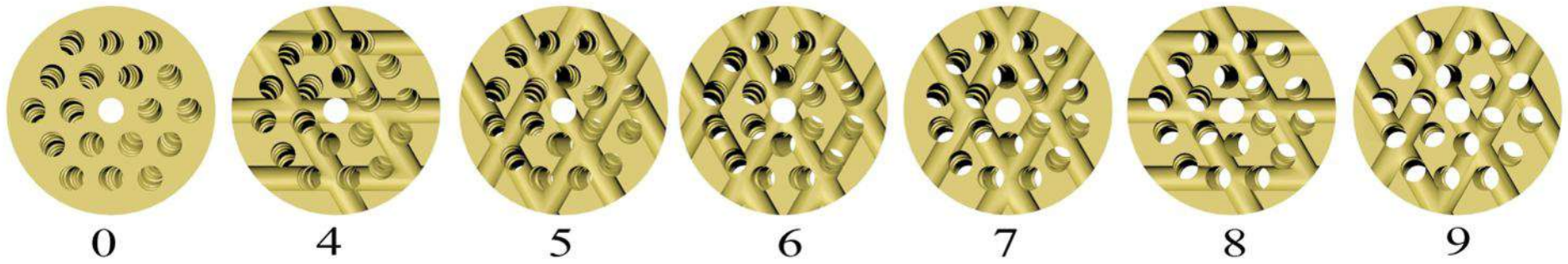

19p\_spag\_min180\_12s\_rhombus\_prop1



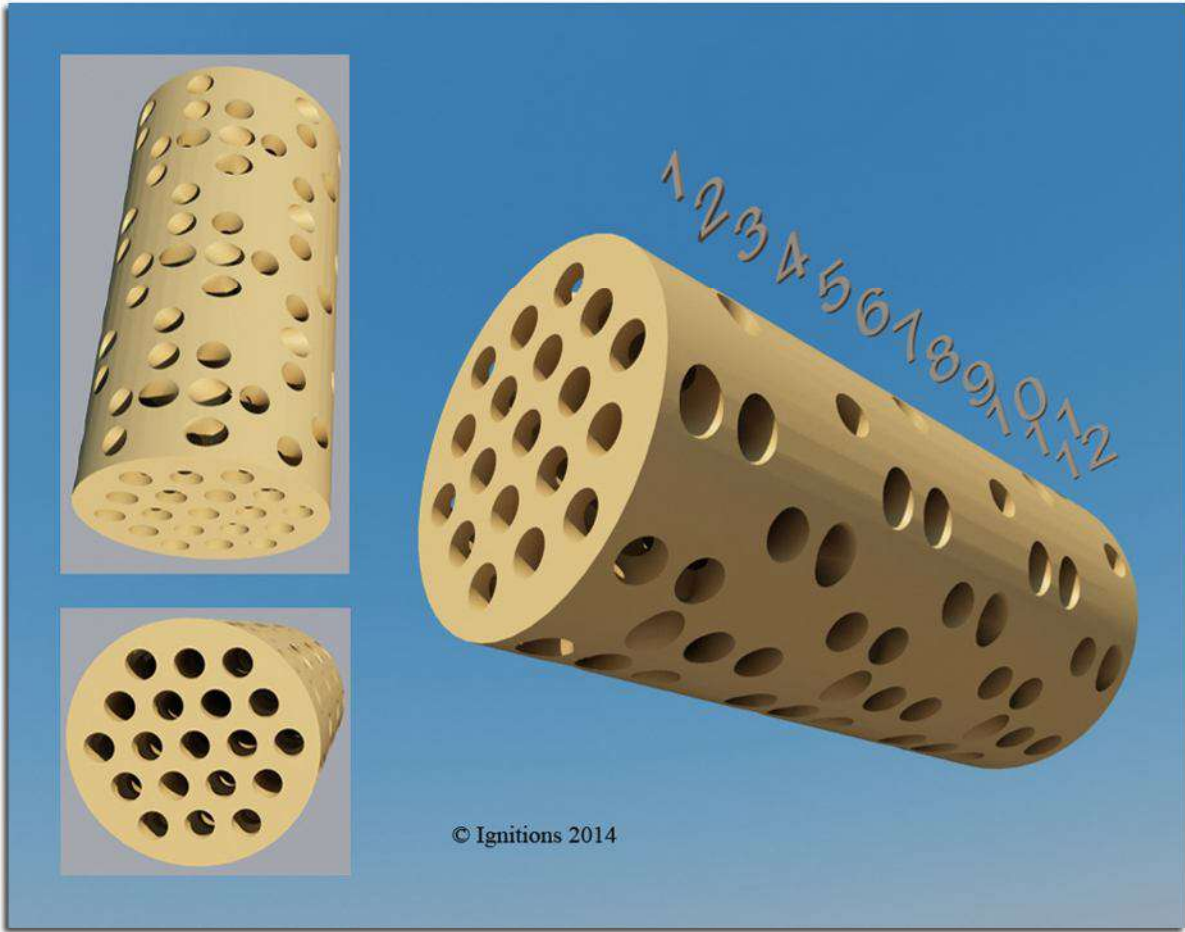



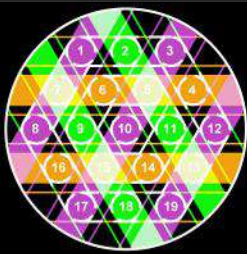

1

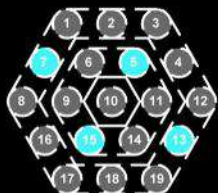

2

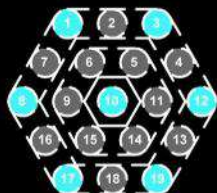

3

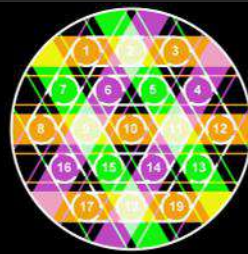
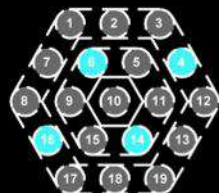

4

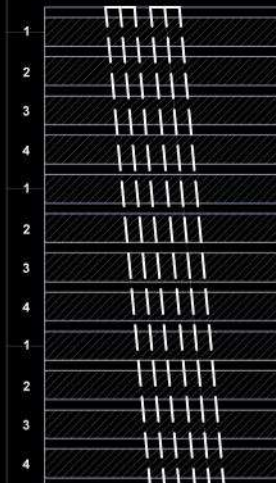
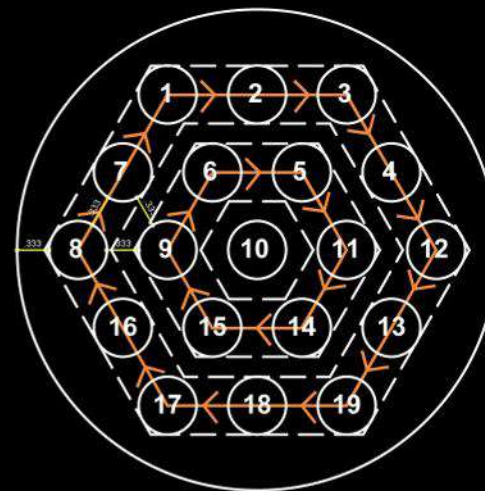
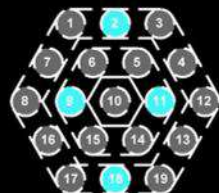

5(1)

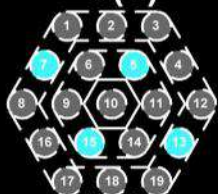

6(2)

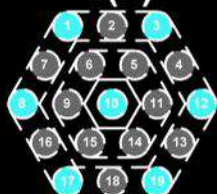

7(3)

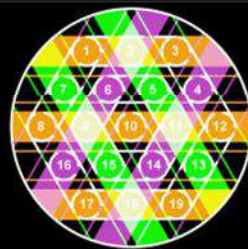
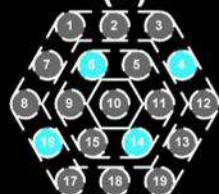

8(4)

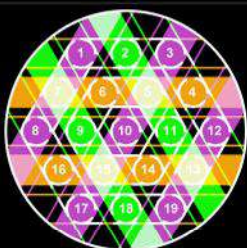
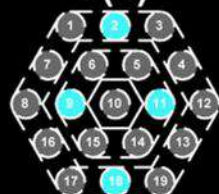

9(1)

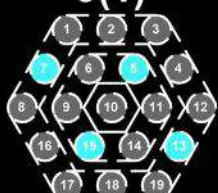

10(2)

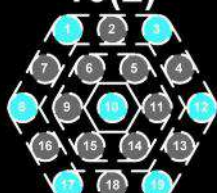

11(3)

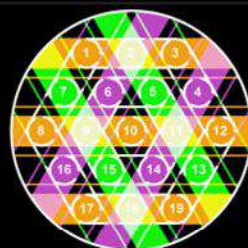
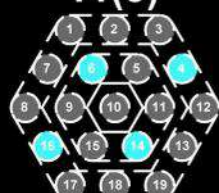

12(4)

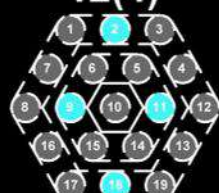

	1	2	3	4	5	6	7	8	9	10	11	12	
	1	2	3	4	1	2	3	4	1	2	3	4	
1	1	3	1	1	1	3	1	1	1	3	1	1	18
2	1	1	1	3	1	1	1	3	1	1	1	3	18
3	1	3	1	1	1	3	1	1	1	3	1	1	18
4	1	1	3	1	1	1	3	1	1	1	3	1	18
5	3	1	1	1	3	1	1	1	3	1	1	1	18
6	1	1	3	1	1	1	3	1	1	1	3	1	18
7	3	1	1	1	3	1	1	1	3	1	1	1	18
8	1	3	1	1	1	3	1	1	1	3	1	1	18
9	1	1	1	3	1	1	1	3	1	1	1	3	18
10	1	3	1	1	1	3	1	1	1	3	1	1	18
11	1	1	1	3	1	1	1	3	1	1	1	3	18
12	1	3	1	1	1	3	1	1	1	3	1	1	18
13	3	1	1	1	3	1	1	1	3	1	1	1	18
14	1	1	3	1	1	1	3	1	1	1	3	1	18
15	3	1	1	1	3	1	1	1	3	1	1	1	18
16	1	1	3	1	1	1	3	1	1	1	3	1	18
17	1	3	1	1	1	3	1	1	1	3	1	1	18
18	1	1	1	3	1	1	1	3	1	1	1	3	18
19	1	3	1	1	1	3	1	1	1	3	1	1	18
	27	33	27	27	27	33	27	27	27	33	27	27	342

- ΧΩΡΙΣ ΔΙΑΣΤΑΥΡΩΣΗ
- 2 ΔΡΟΜΩΝ ΔΙΑΣΤΑΥΡΩΣΗ
- 3 ΔΡΟΜΩΝ ΔΙΑΣΤΑΥΡΩΣΗ
- 4 ΔΡΟΜΩΝ ΔΙΑΣΤΑΥΡΩΣΗ

19p\_spag\_min180\_12slice\_triangle\_prop1

© Ignitions 2014





0



1



2

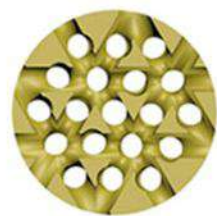
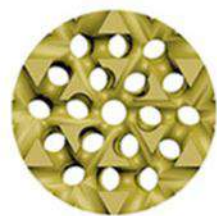
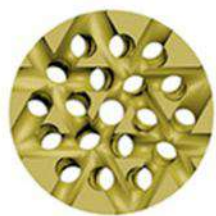
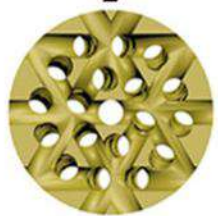
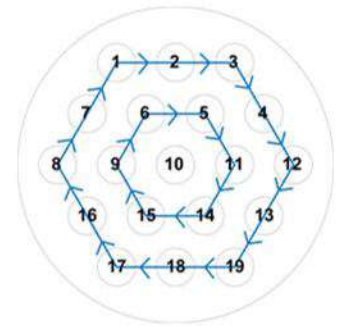

11

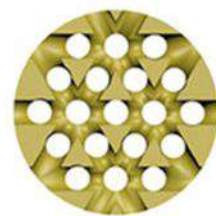

12

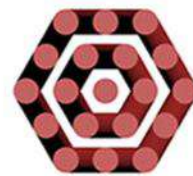
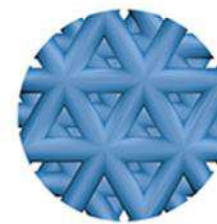
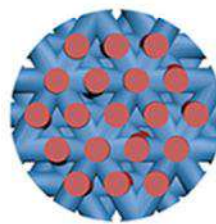

19p\_spag\_min180\_12s\_triangle\_prop1

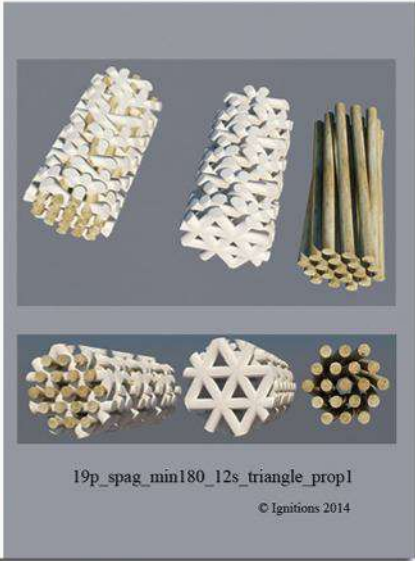



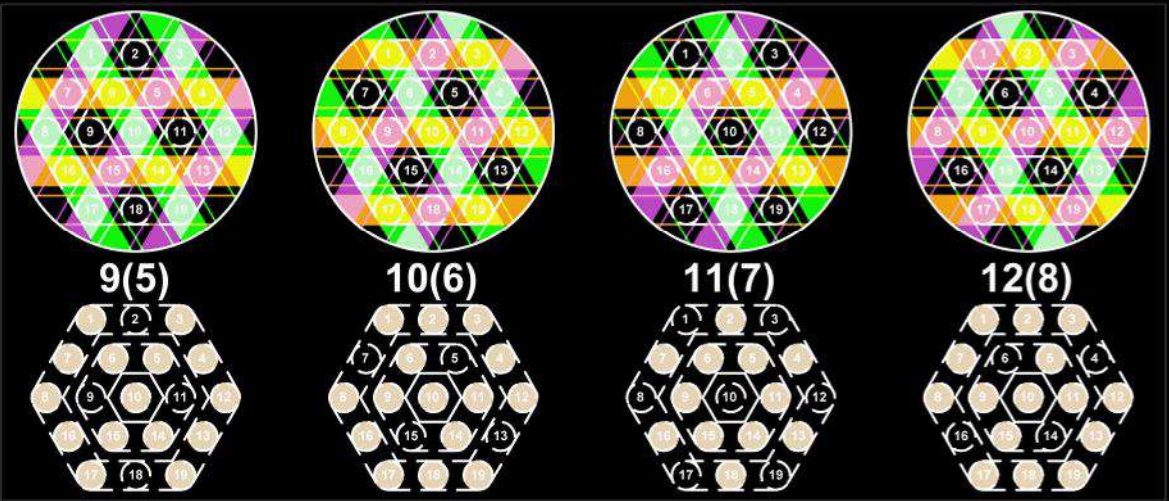
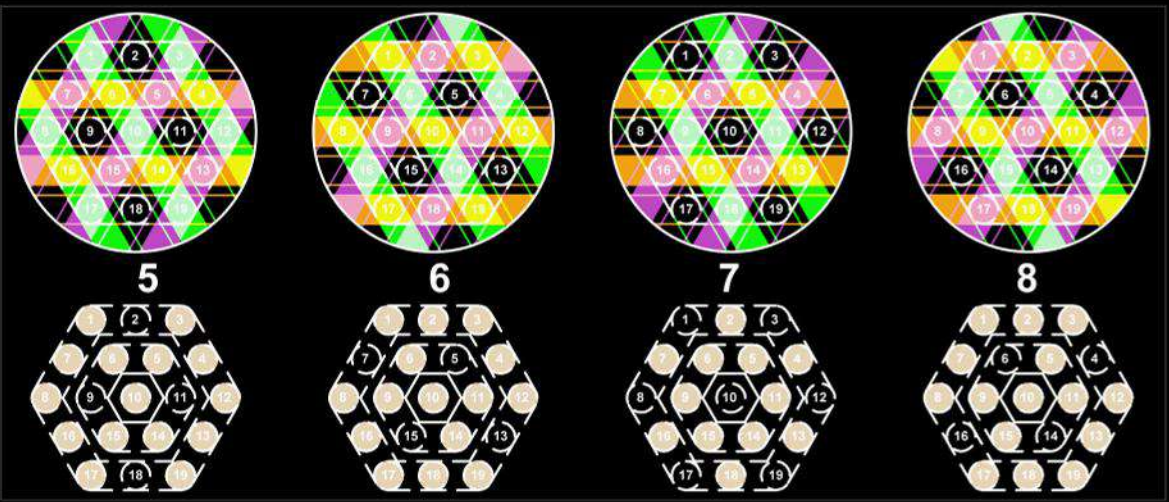
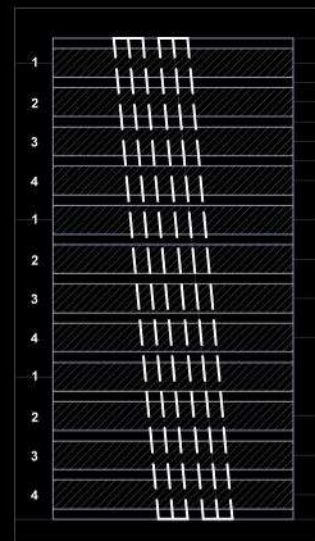
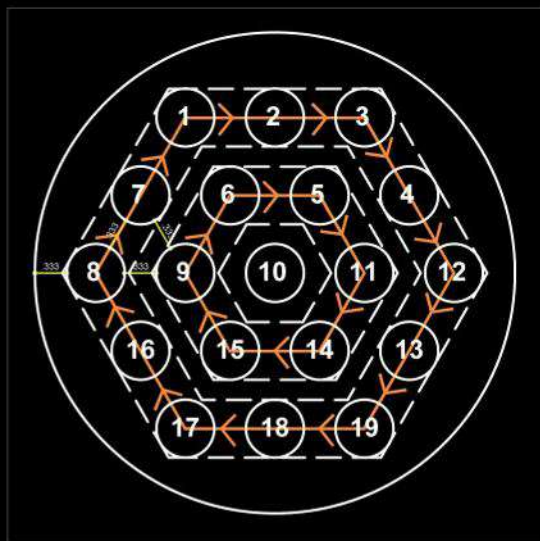
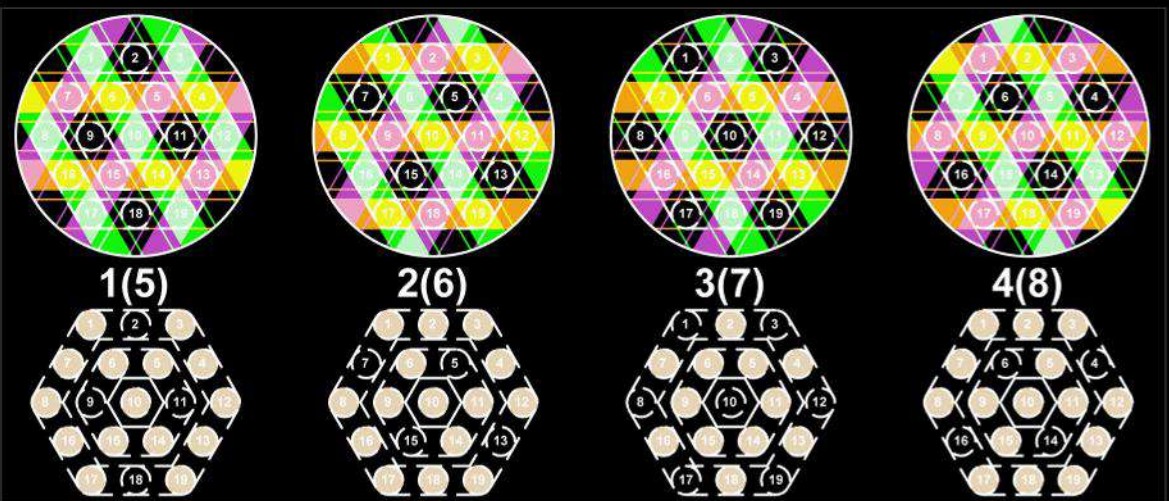

	1	2	3	4	5	6	7	8	9	10	11	12	
	5	6	7	8	5	6	7	8	5	6	7	8	
1	2	2	0	2	2	2	0	2	2	2	0	2	18
2	0	2	2	2	0	2	2	2	0	2	2	2	18
3	2	2	0	2	2	2	0	2	2	2	0	2	18
4	2	2	2	0	2	2	2	0	2	2	2	0	18
5	2	0	2	2	2	0	2	2	2	0	2	2	18
6	2	2	2	0	2	2	2	0	2	2	2	0	18
7	2	0	2	2	2	0	2	2	2	0	2	2	18
8	2	2	0	2	2	2	0	2	2	2	0	2	18
9	0	2	2	2	0	2	2	2	0	2	2	2	18
10	2	2	0	2	2	2	0	2	2	2	0	2	18
11	0	2	2	2	0	2	2	2	0	2	2	2	18
12	2	2	0	2	2	2	0	2	2	2	0	2	18
13	2	0	2	2	2	0	2	2	2	0	2	2	18
14	2	2	2	0	2	2	2	0	2	2	2	0	18
15	2	0	2	2	2	0	2	2	2	0	2	2	18
16	2	2	2	0	2	2	2	0	2	2	2	0	18
17	2	2	0	2	2	2	0	2	2	2	0	2	18
18	0	2	2	2	0	2	2	2	0	2	2	2	18
19	2	2	0	2	2	2	0	2	2	2	0	2	18
	30	30	24	30	30	30	24	30	30	30	24	30	342

- ΧΩΡΙΣ ΔΙΑΣΤΑΥΡΩΣΗ
- 2 ΑΡΟΜΟΝ ΔΙΑΣΤΑΥΡΩΣΗ
- 3 ΑΡΟΜΟΝ ΔΙΑΣΤΑΥΡΩΣΗ
- 4 ΑΡΟΜΟΝ ΔΙΑΣΤΑΥΡΩΣΗ

19p\_spag\_min180\_12slice\_tri-hex\_prop2





0



1



2

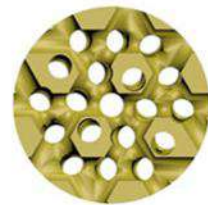
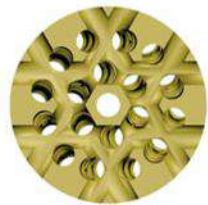
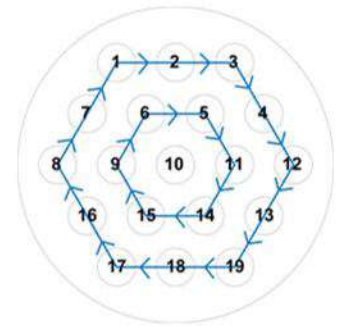

11

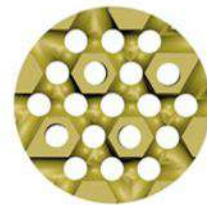

12

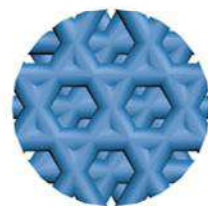
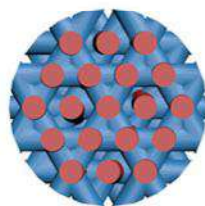
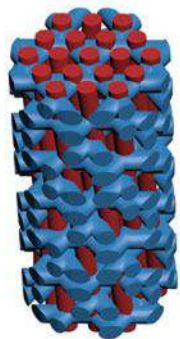

19p\_spag\_min180\_12s\_tri-hex\_prop2



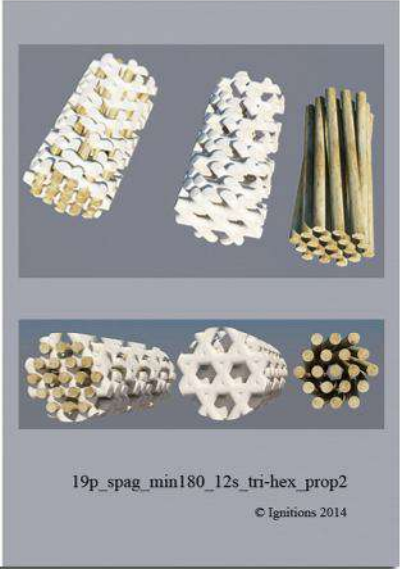



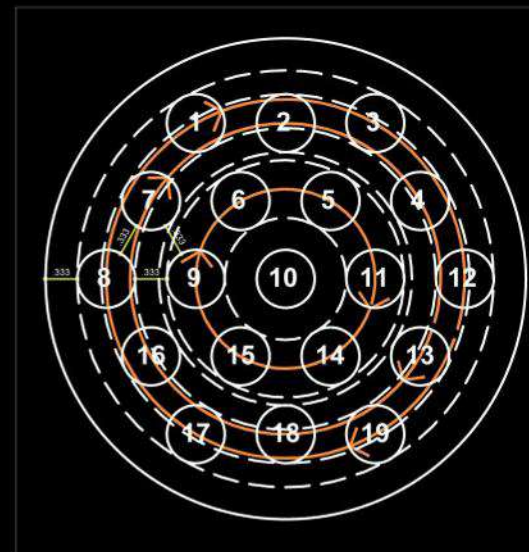
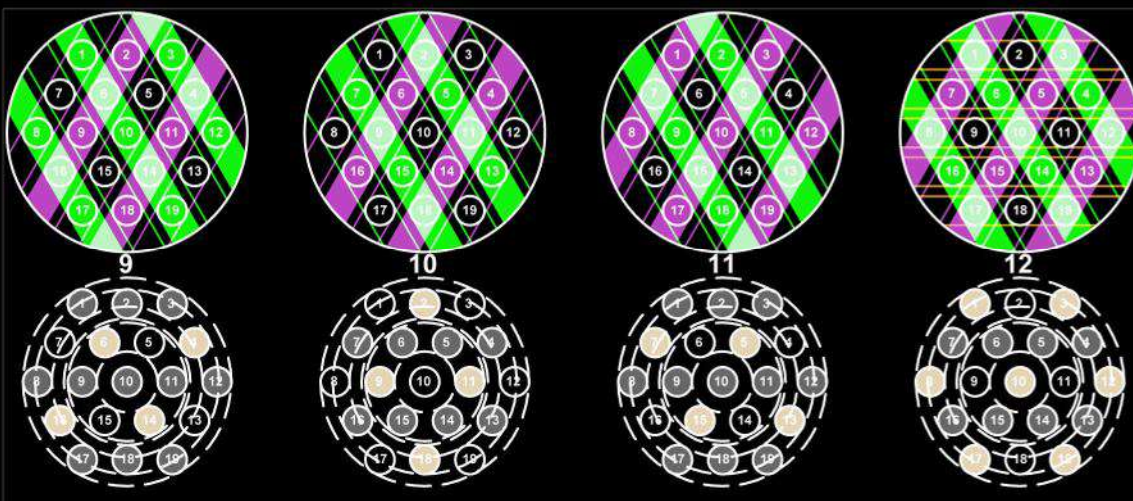
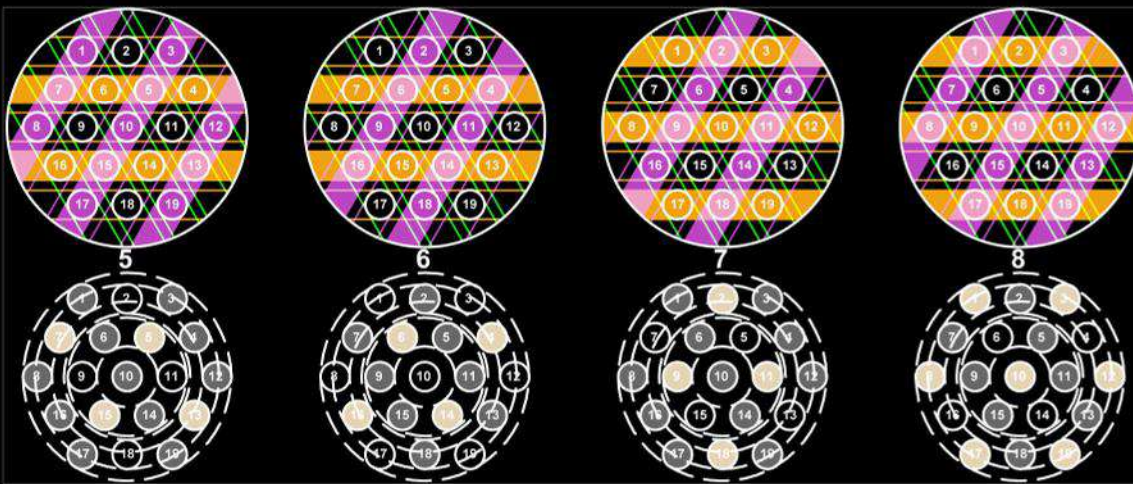
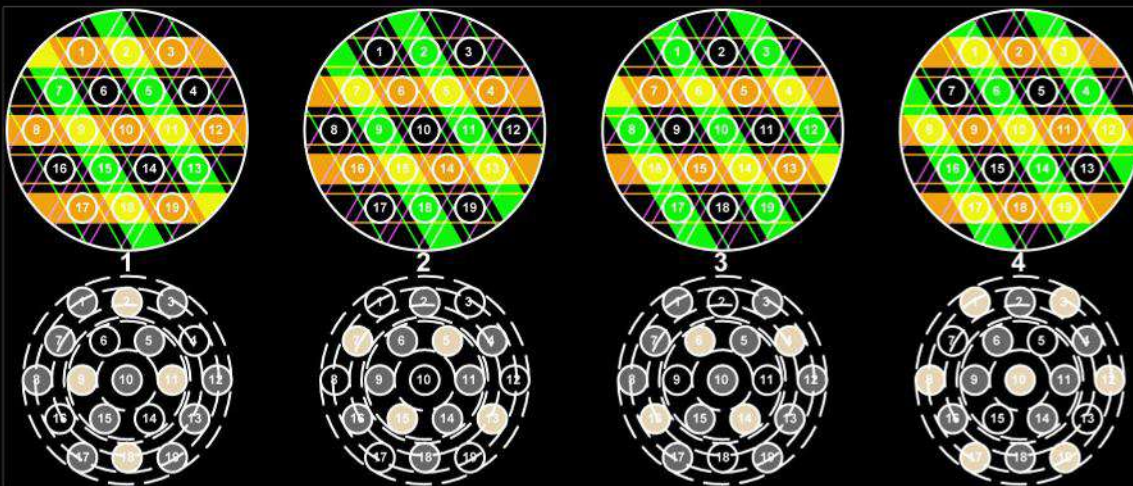

	1	2	3	4	5	6	7	8	9	10	11	12	
1	1	0	1	2	1	0	1	2	1	0	1	2	12
2	2	1	1	0	0	1	2	1	1	2	1	0	12
3	1	0	1	2	1	0	1	2	1	0	1	2	12
4	0	1	2	1	1	2	1	0	2	1	0	1	12
5	1	2	0	1	2	1	0	1	0	1	2	1	12
6	0	1	2	1	1	2	1	0	2	1	0	1	12
7	1	2	0	1	2	1	0	1	0	1	2	1	12
8	1	0	1	2	1	0	1	2	1	0	1	2	12
9	2	1	1	0	0	1	2	1	1	2	1	0	12
10	1	0	1	2	1	0	1	2	1	0	1	2	12
11	2	1	1	0	0	1	2	1	1	2	1	0	12
12	1	0	1	2	1	0	1	2	1	0	1	2	12
13	1	2	0	1	2	1	0	1	0	1	2	1	12
14	0	1	2	1	1	2	1	0	2	1	0	1	12
15	1	2	0	1	2	1	0	1	0	1	2	1	12
16	0	1	2	1	1	2	1	0	2	1	0	1	12
17	1	0	1	2	1	0	1	2	1	0	1	2	12
18	2	1	1	0	0	1	2	1	1	2	1	0	12
19	1	0	1	2	1	0	1	2	1	0	1	2	12
	19	16	19	22	19	16	19	22	19	16	19	22	228

- ΧΩΡΙΣ ΔΙΑΣΤΑΥΡΩΣΗ
- 2 ΔΡΟΜΟΝ ΔΙΑΣΤΑΥΡΩΣΗ
- 3 ΔΡΟΜΟΝ ΔΙΑΣΤΑΥΡΩΣΗ



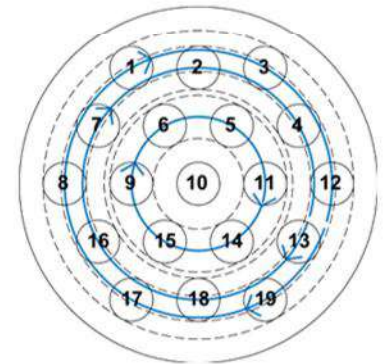
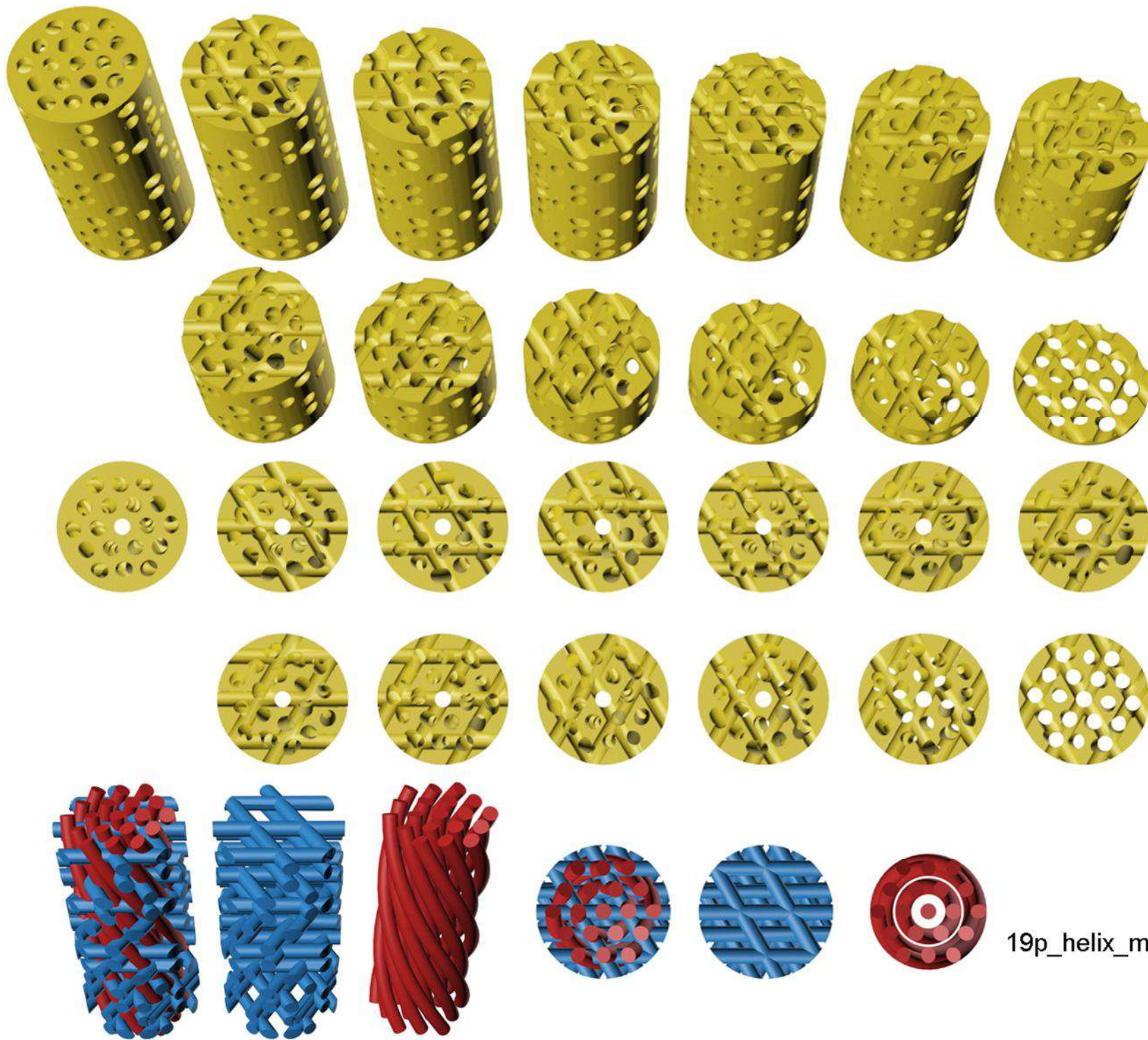

19p\_helix\_min180\_12s\_rhombus\_prop1

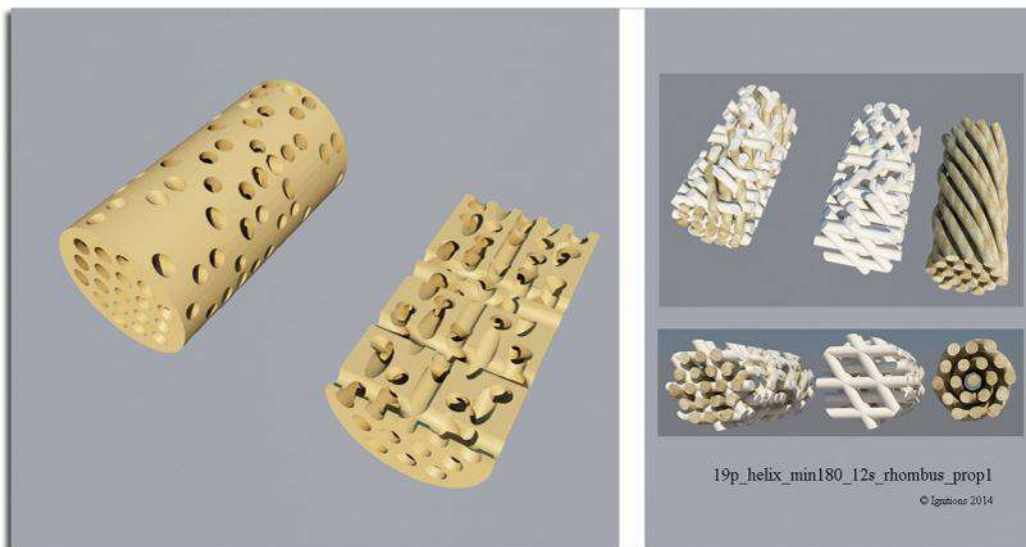



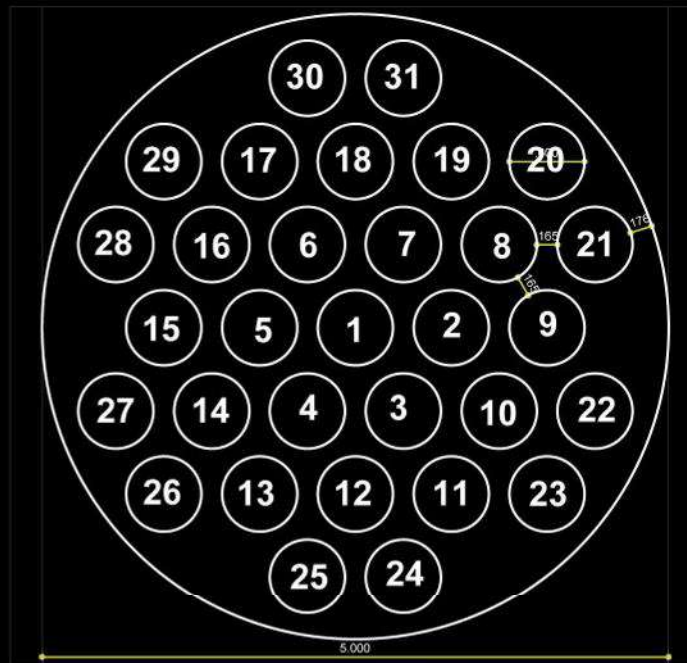
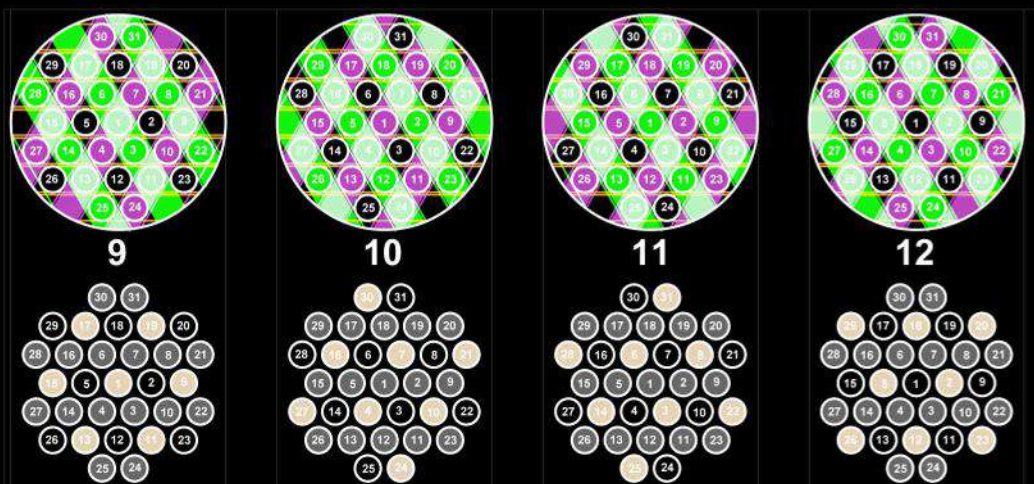
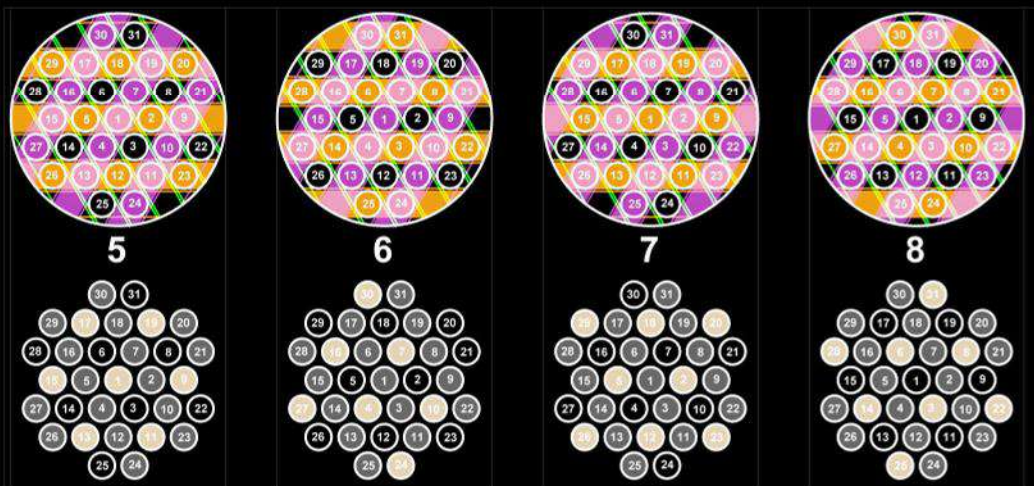
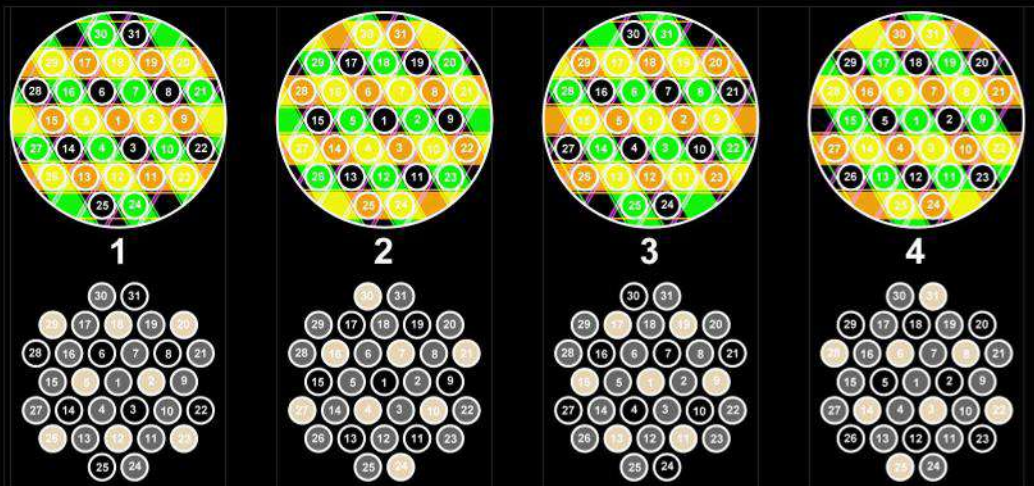

	1	2	3	4	5	6	7	8	9	10	11	12		
1	1	1	0	2	1	2	1	1	0	2	1	1	0	12
2	2	1	1	0	1	0	2	1	0	1	1	1	2	12
3	0	1	1	2	0	1	1	2	1	0	2	1	1	12
4	1	2	0	1	1	2	0	1	1	2	0	1	1	12
5	2	1	1	0	1	0	2	1	0	1	1	2	1	12
6	0	1	1	2	0	1	1	2	1	0	2	1	1	12
7	1	2	0	1	1	2	0	1	1	2	0	1	1	12
8	0	1	1	2	0	1	1	2	1	0	2	1	1	12
9	1	0	2	1	2	1	1	0	2	1	1	0	1	12
10	1	2	0	1	1	2	0	1	1	2	0	1	1	12
11	1	0	2	1	2	1	1	0	2	1	1	0	1	12
12	2	1	1	0	1	0	2	1	0	1	1	2	1	12
13	1	0	2	1	2	1	1	0	2	1	1	0	1	12
14	0	1	1	2	0	1	1	2	1	0	2	1	1	12
15	1	0	2	1	2	1	1	0	2	1	1	0	1	12
16	1	2	0	1	1	2	0	1	1	2	0	1	1	12
17	1	0	2	1	2	1	1	0	2	1	1	0	1	12
18	2	1	1	0	1	0	2	1	0	1	1	2	1	12
19	1	0	2	1	2	1	1	0	2	1	1	0	1	12
20	2	1	1	0	1	0	2	1	0	1	1	2	1	12
21	1	2	0	1	1	2	0	1	1	2	0	1	1	12
22	0	1	1	2	0	1	1	2	1	0	2	1	1	12
23	2	1	1	0	1	0	2	1	0	1	1	2	1	12
24	1	2	0	1	1	2	0	1	1	2	0	1	1	12
25	0	1	1	2	0	1	1	2	1	0	2	1	1	12
26	2	1	1	0	1	0	2	1	0	1	1	2	1	12
27	1	2	0	1	1	2	0	1	1	2	0	1	1	12
28	0	1	1	2	0	1	1	2	1	0	2	1	1	12
29	2	1	1	0	1	0	2	1	0	1	1	2	1	12
30	1	2	0	1	1	2	0	1	1	2	0	1	1	12
31	0	1	1	2	0	1	1	2	1	0	2	1	1	12
	31	32	30	31	30	31	31	32	30	31	31	32	372	

ΧΩΡΙΣ ΑΝΤΑΥΠΟΙΣΗ  
 2 ΑΠΟΜΟΝ ΑΝΤΑΥΠΟΙΣΗ  
 3 ΑΠΟΜΟΝ ΑΝΤΑΥΠΟΙΣΗ



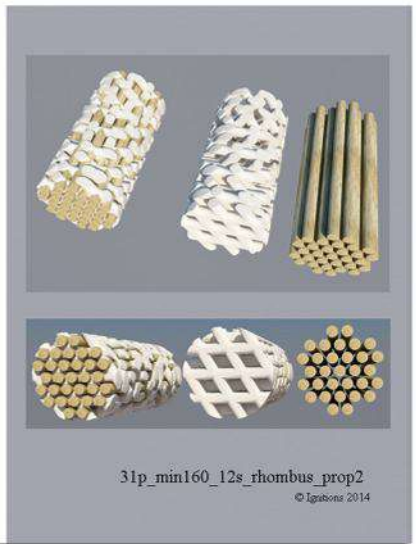



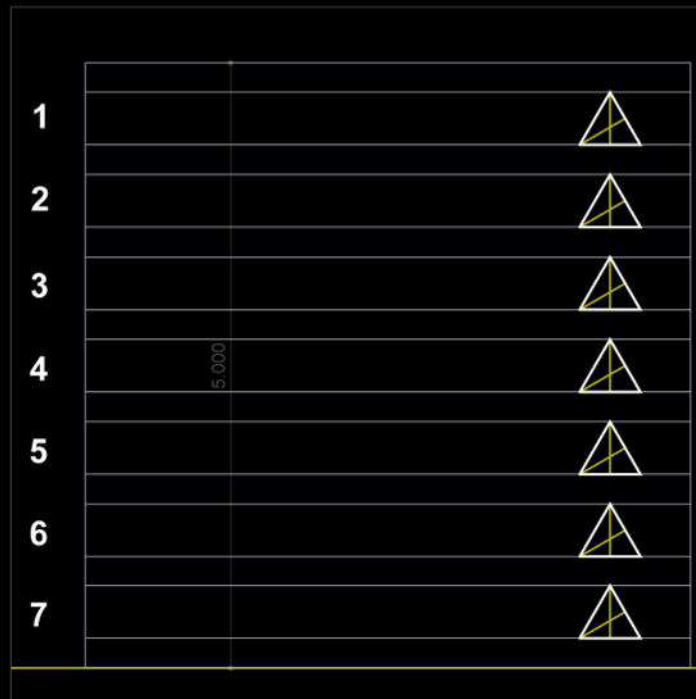
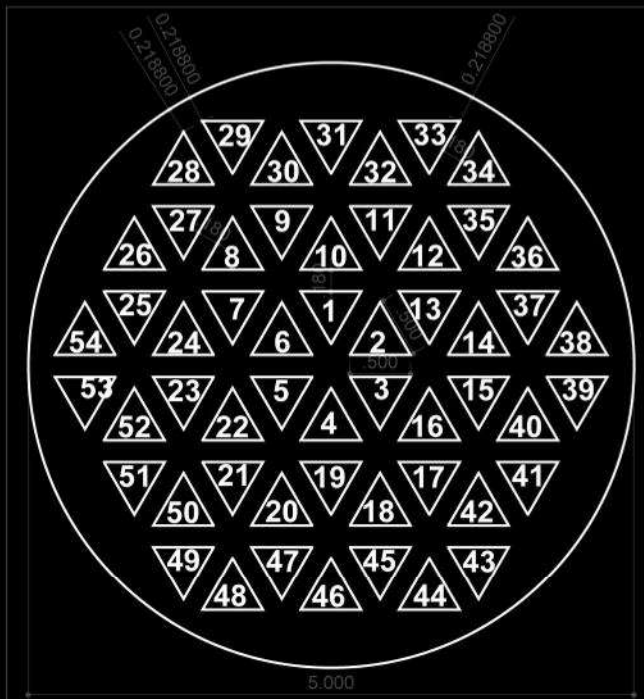
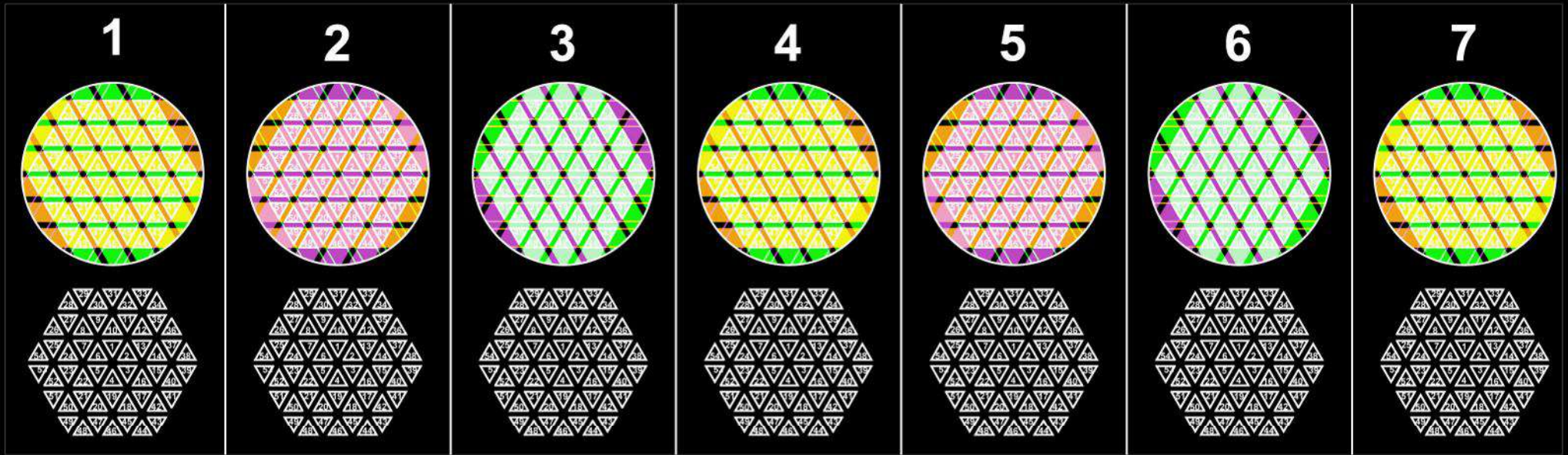



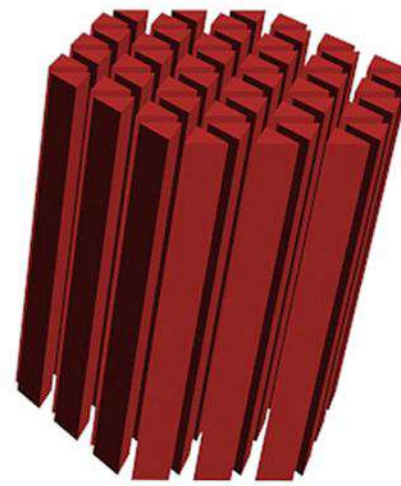
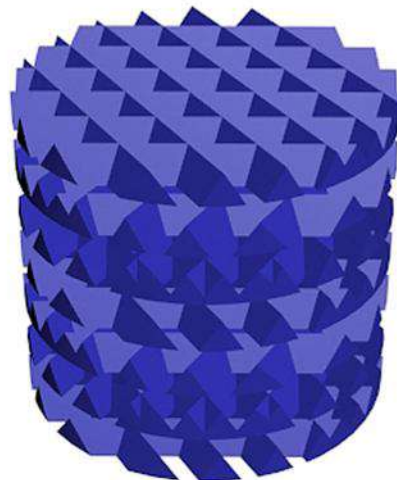
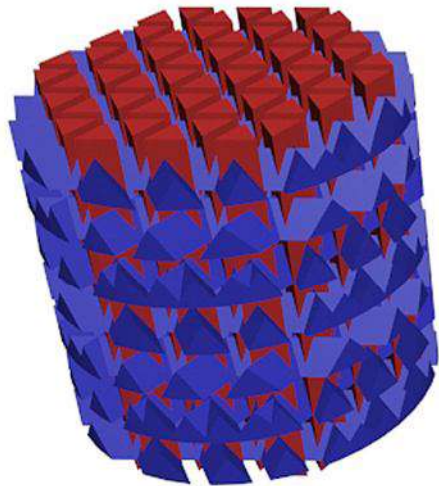
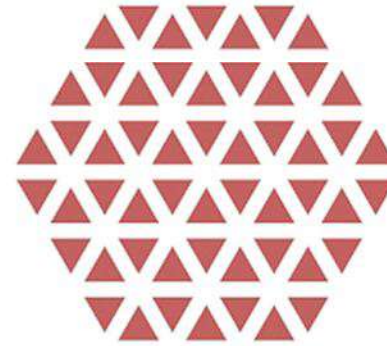
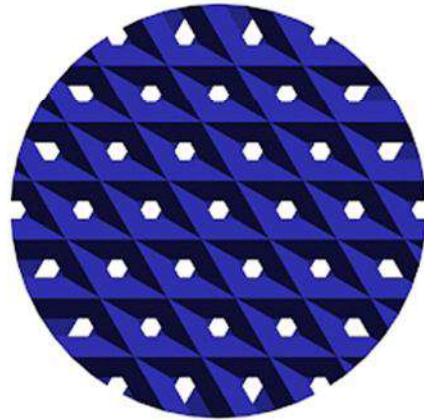
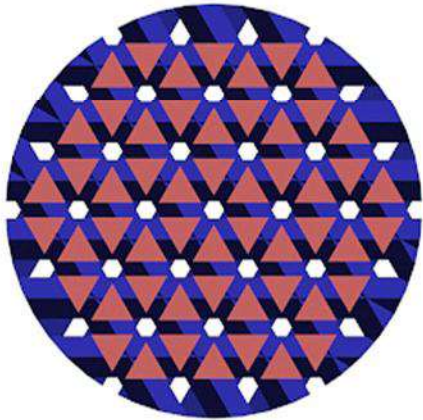
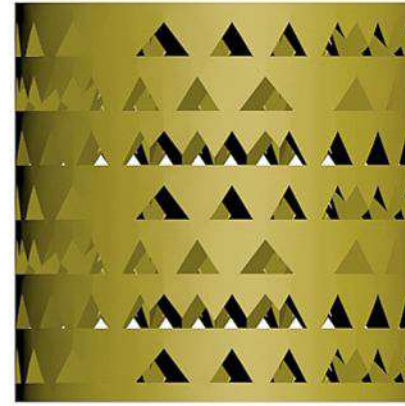
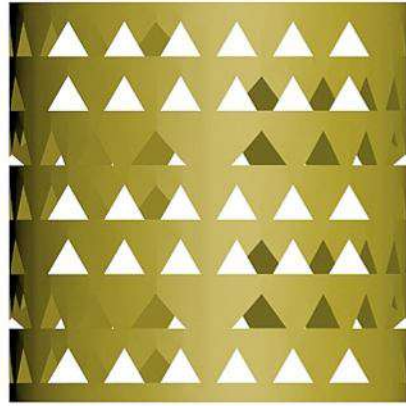
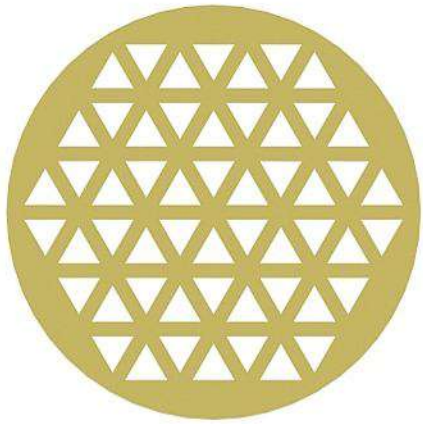

54p\_min180\_7s\_rhombus\_prop1

© Ignitions 2014



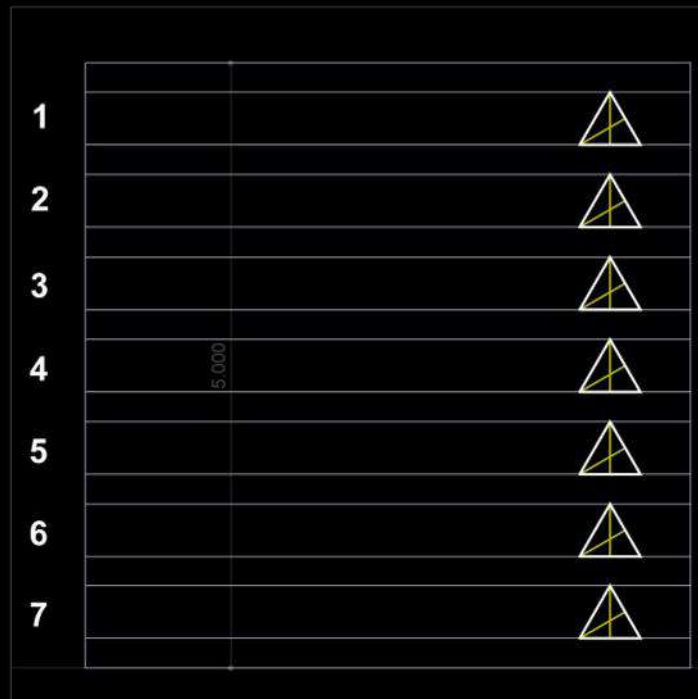
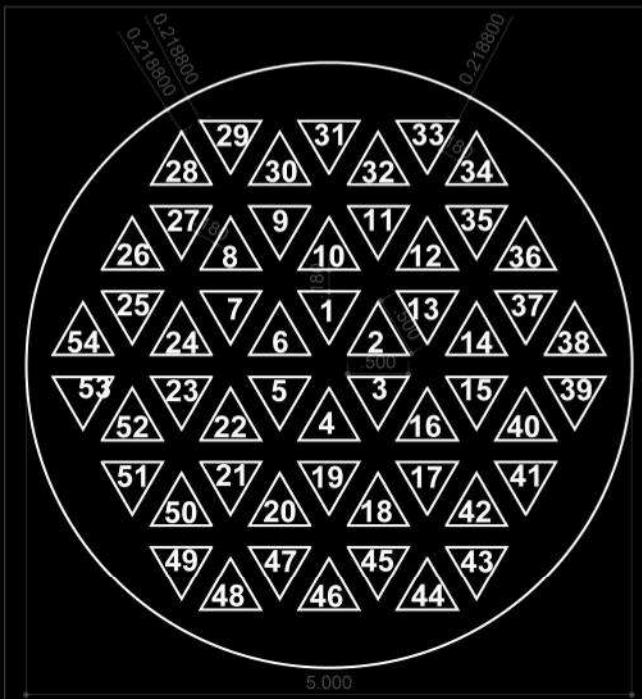
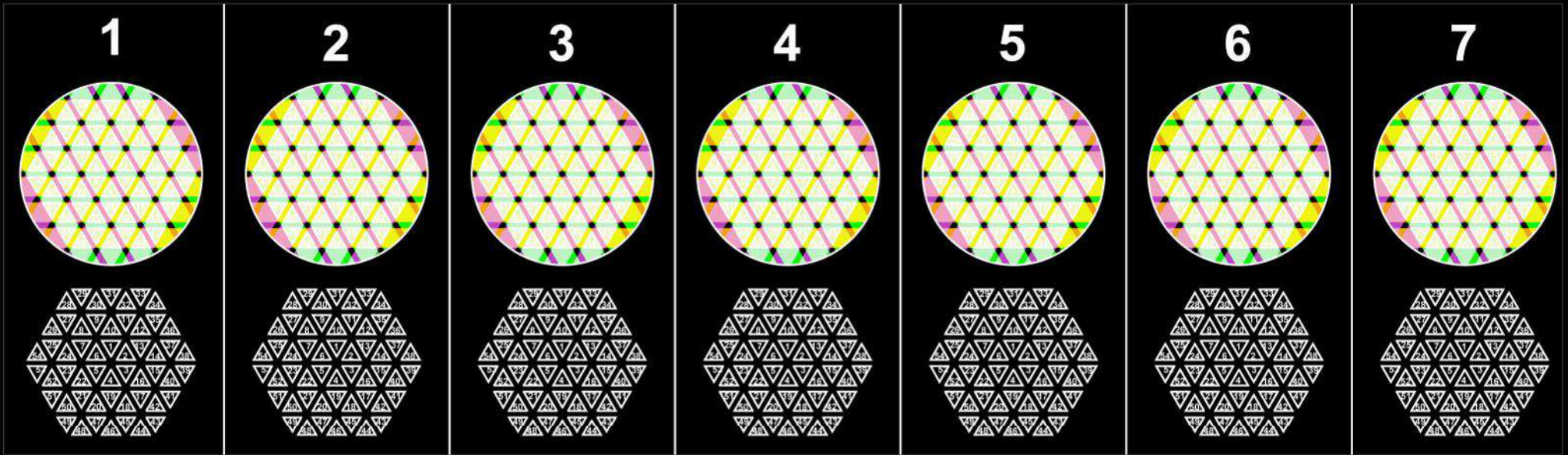

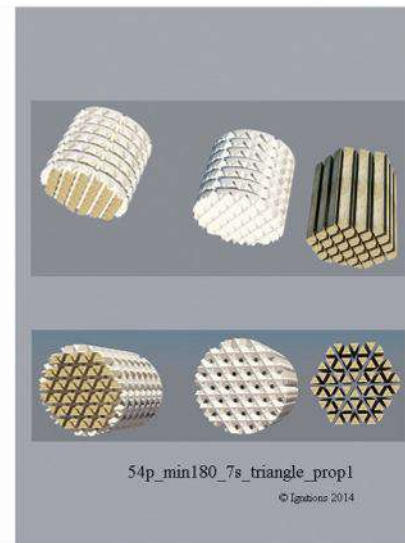
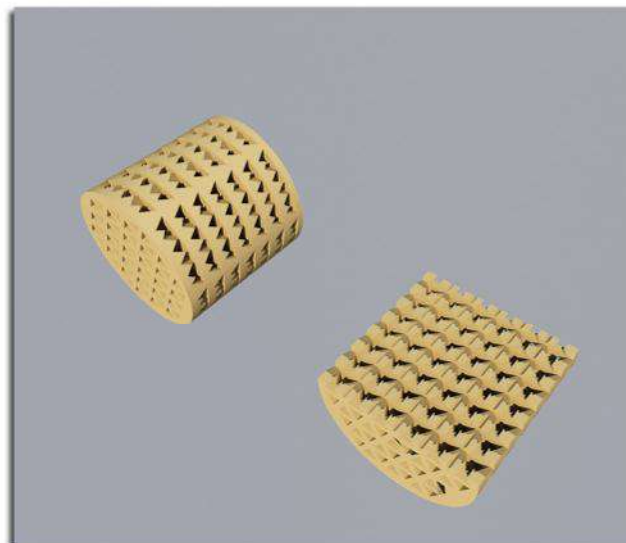
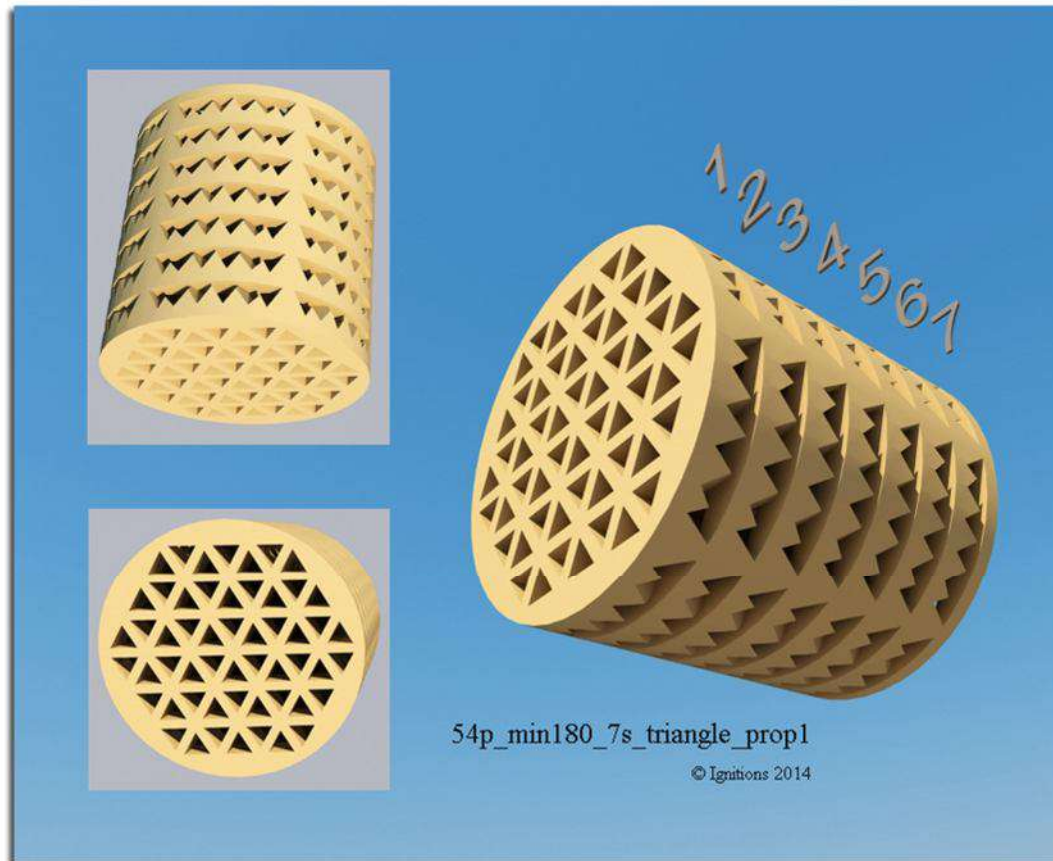



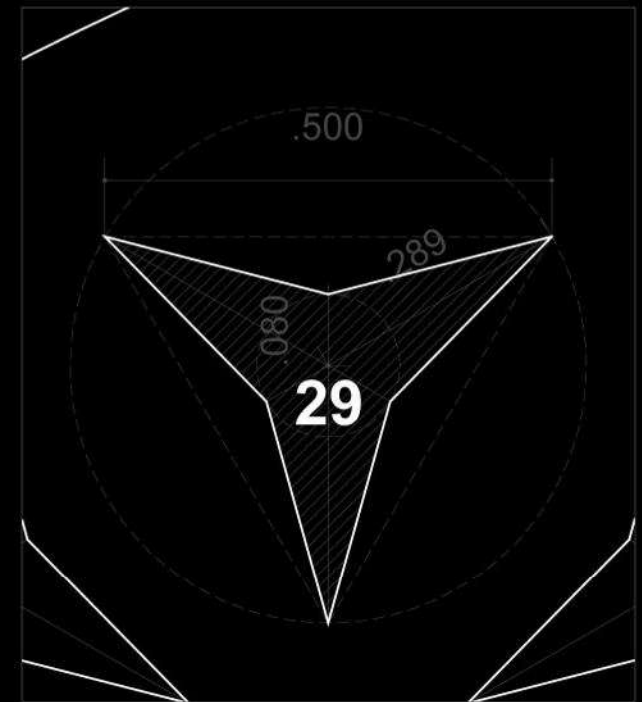
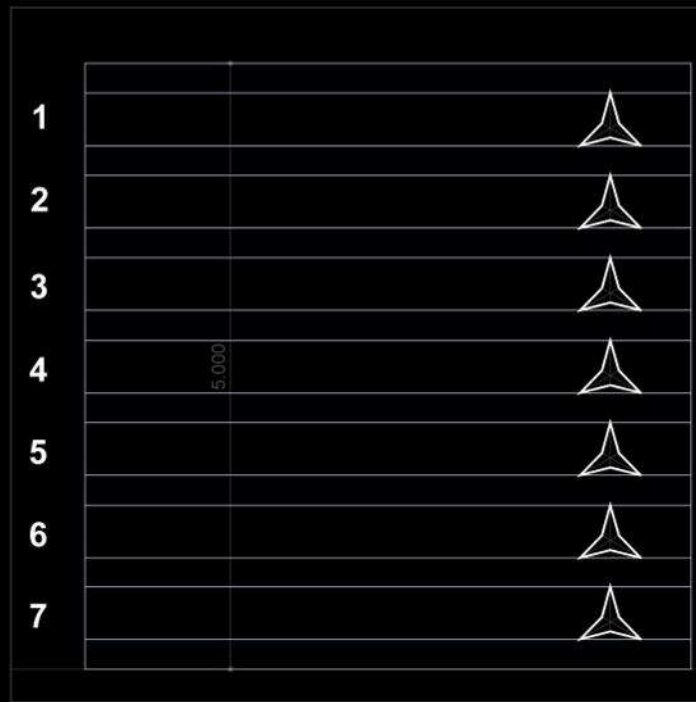
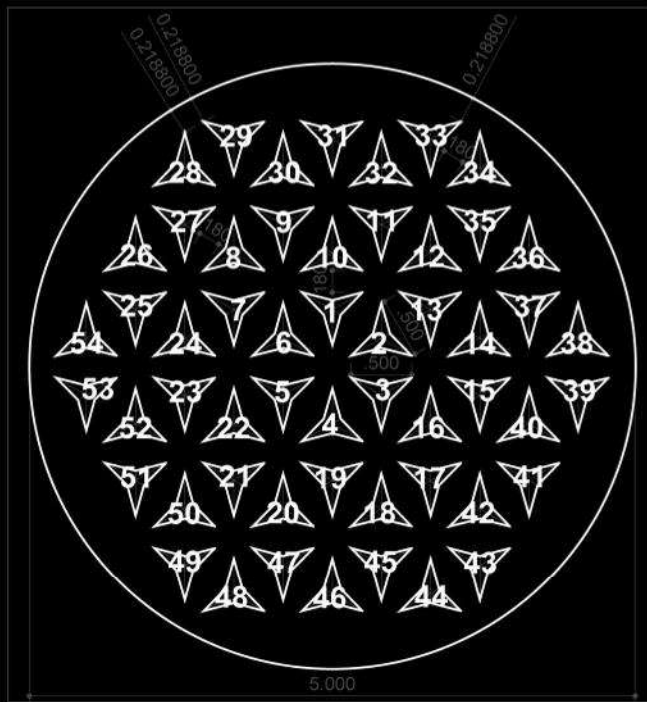
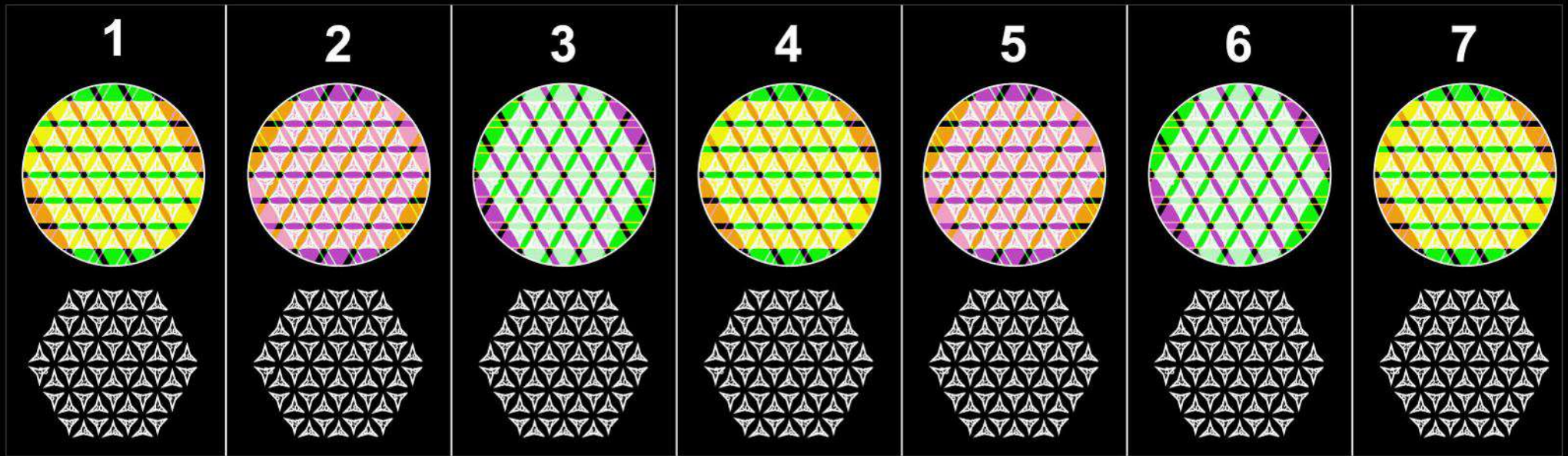

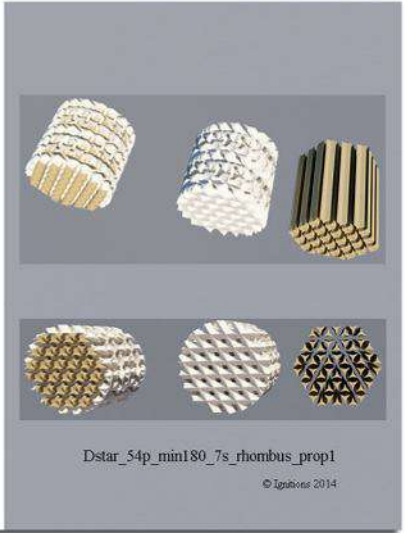
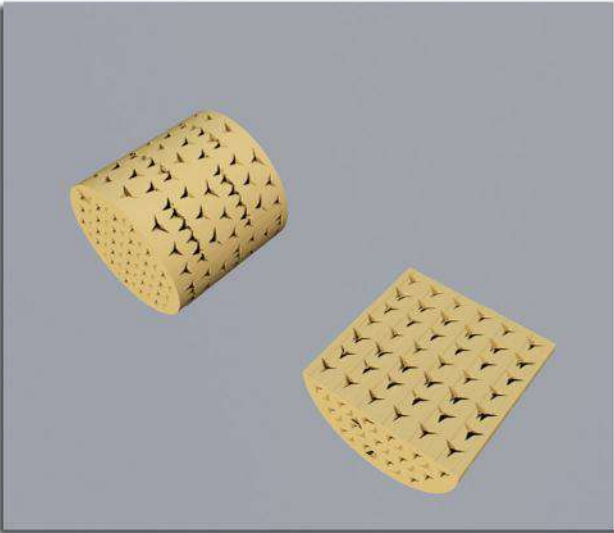
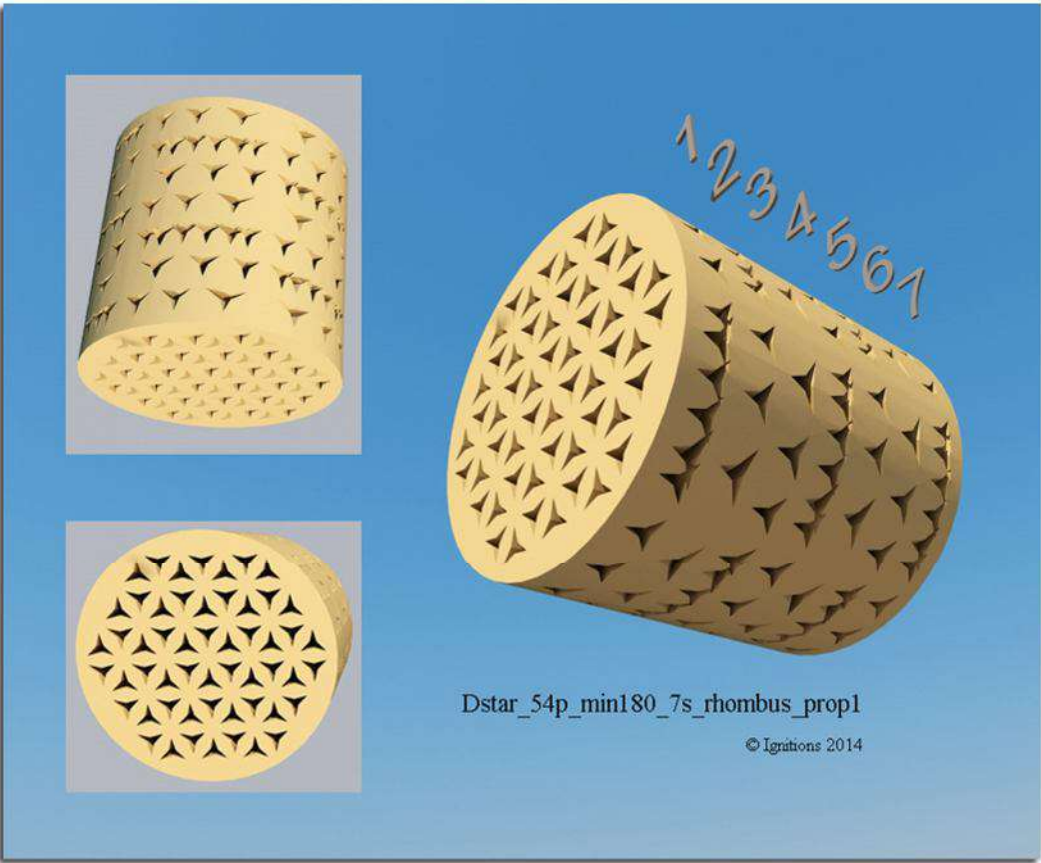



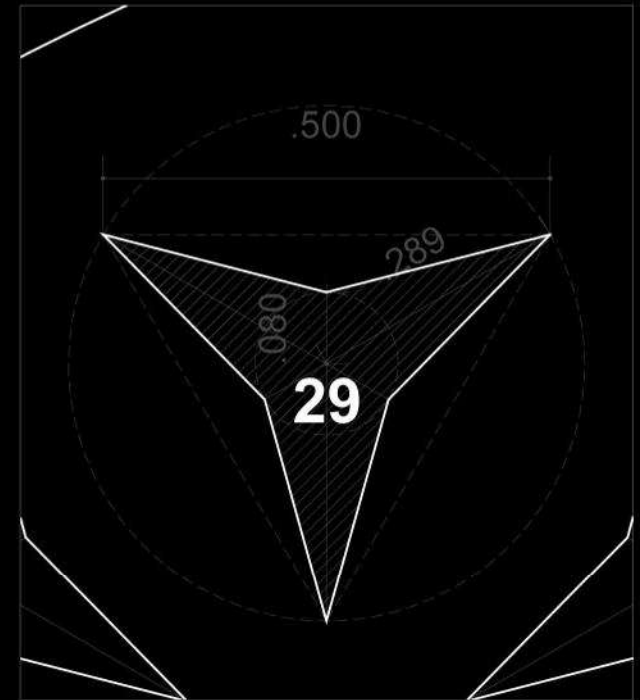
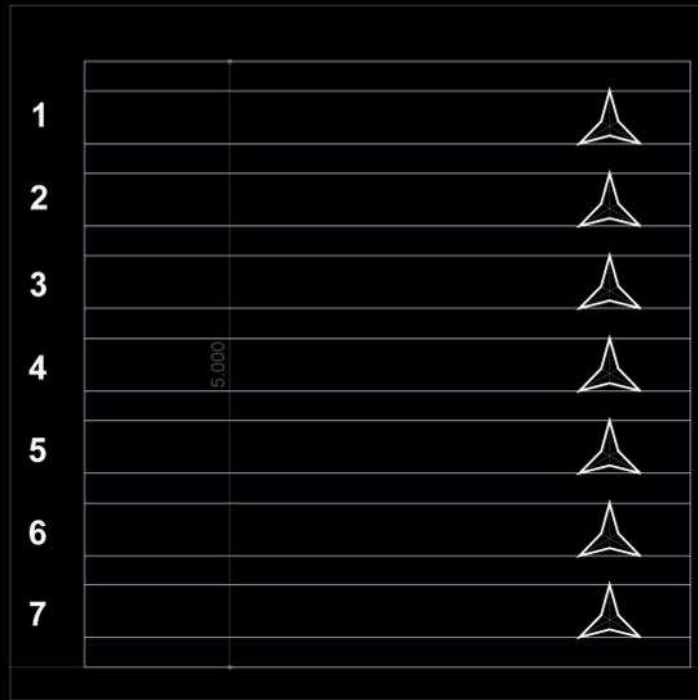
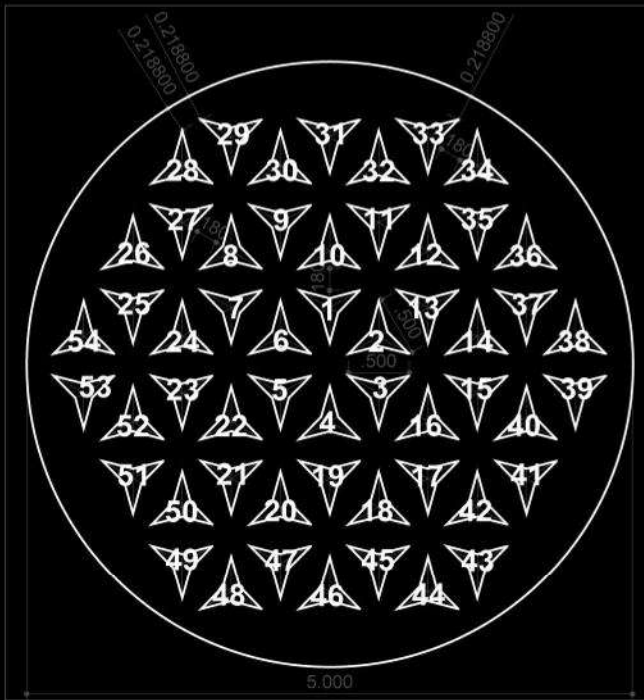
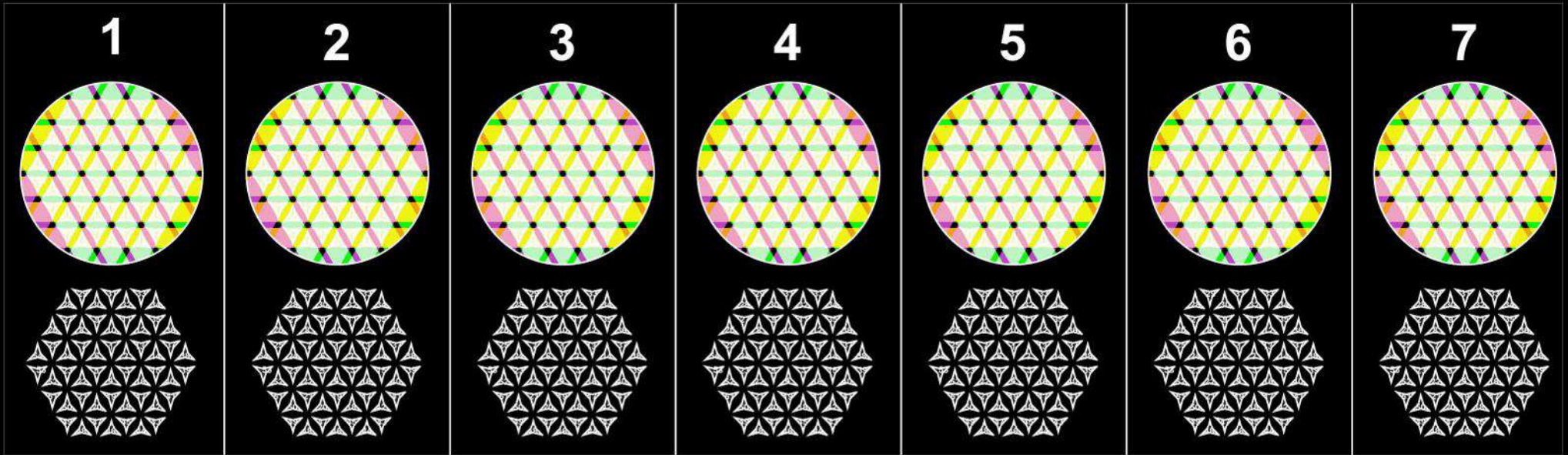

Dstar\_54p\_160&180\_7s\_triangle\_prop1

© Ignitions 2014

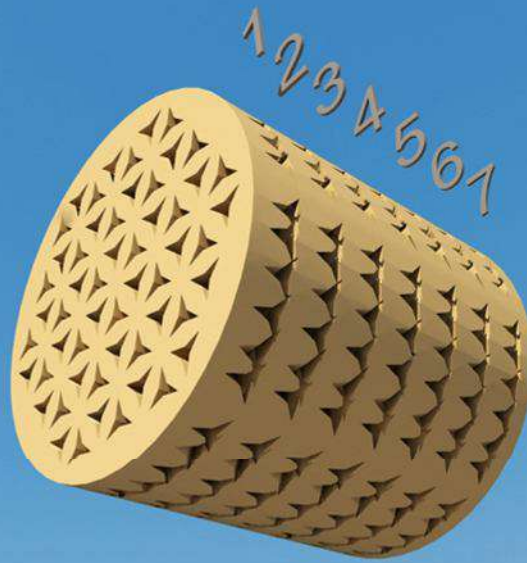
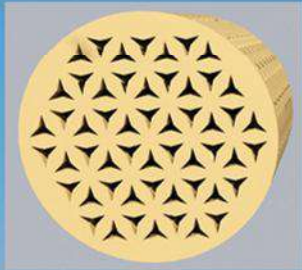

Dstar\_54p\_min180\_7s\_triangle\_prop1

© Ignitions 2014

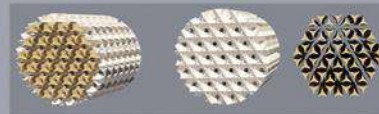
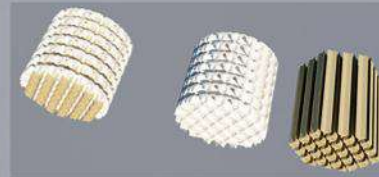
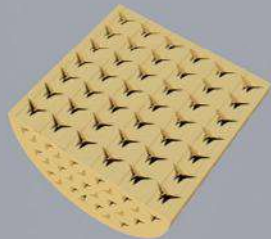

Dstar\_54p\_min180\_7s\_triangle\_prop1

© Ignitions 2014



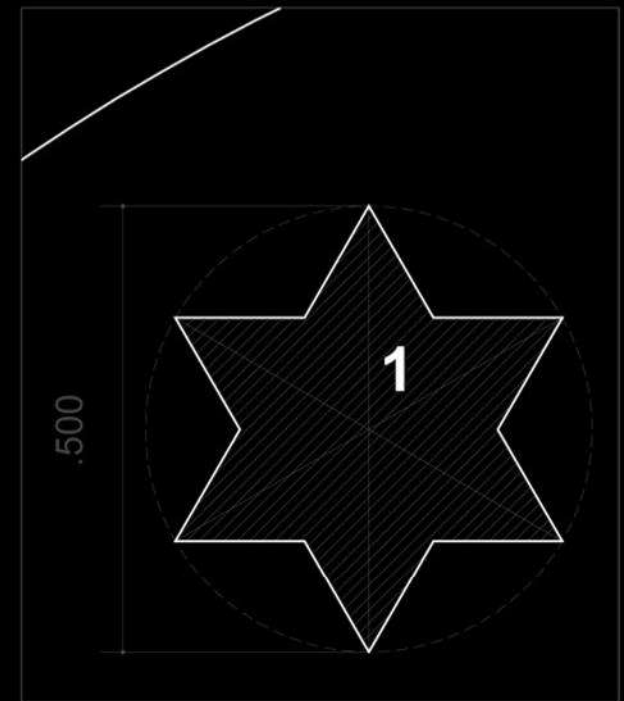
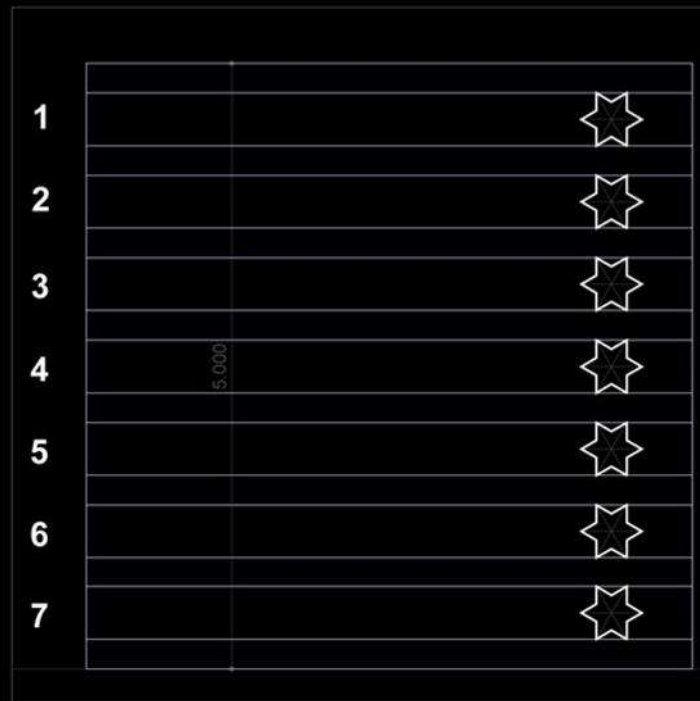
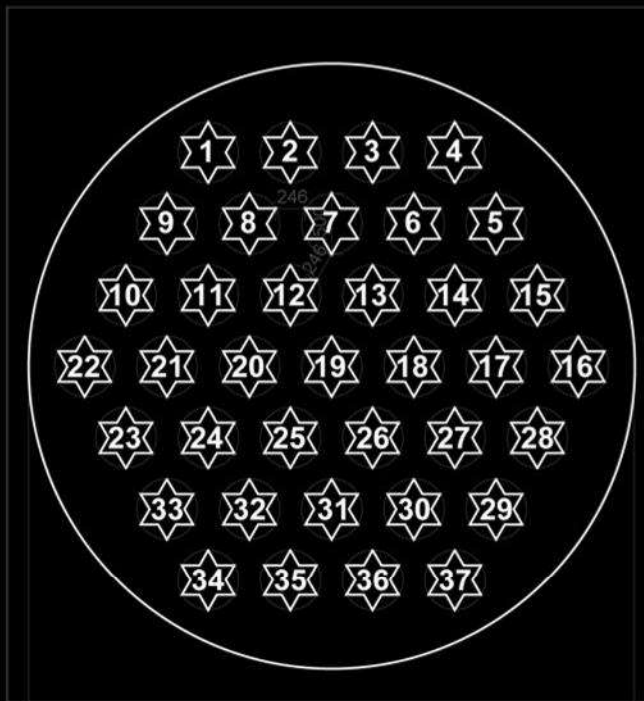
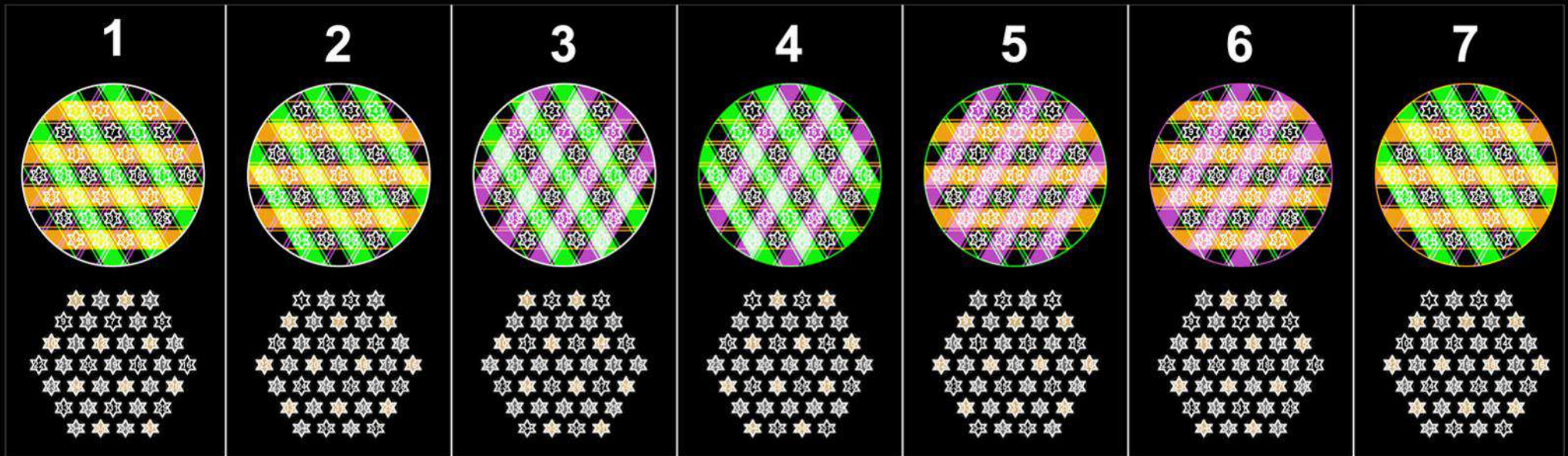

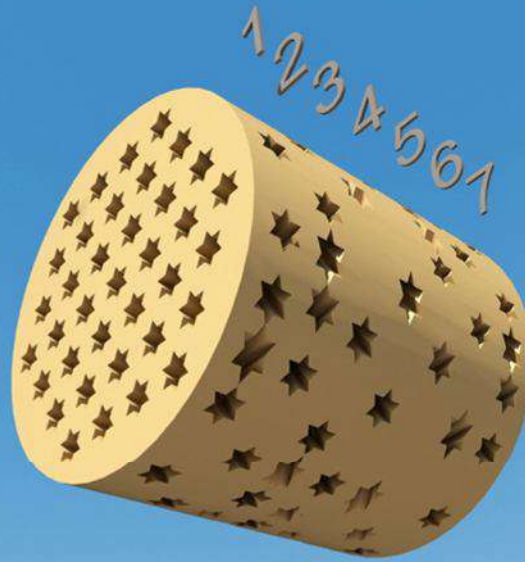

Dstar6\_37p\_min180\_7s\_rhombus\_prop1

© Ignitions 2014

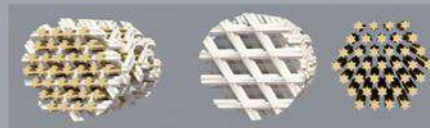
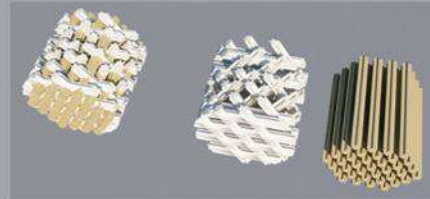

Dstar6\_37p\_min180\_7s\_rhombus\_prop1

© Ignitions 2014



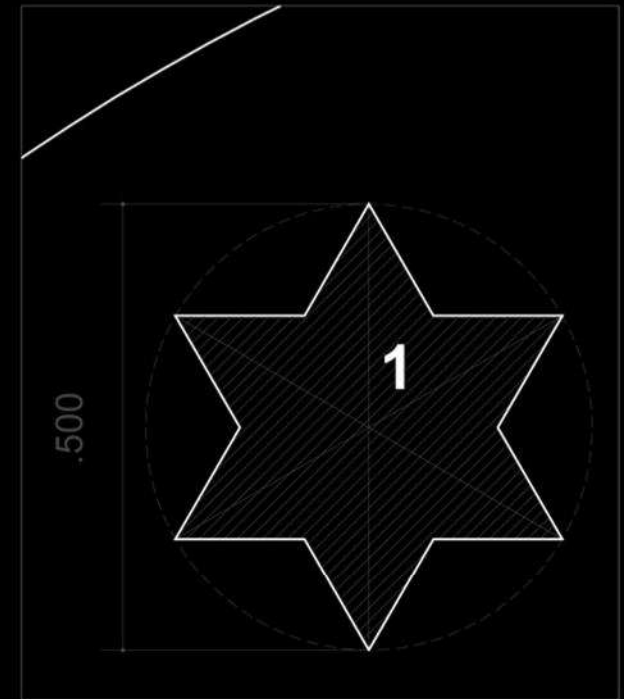
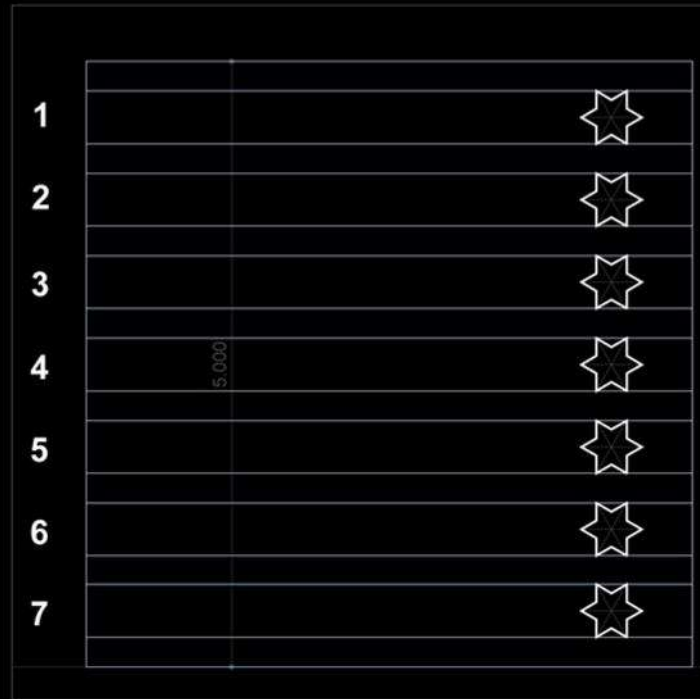
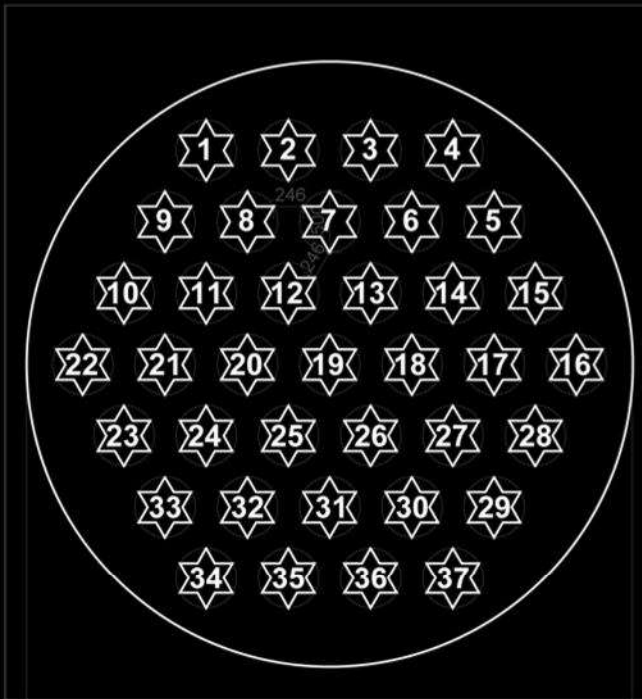
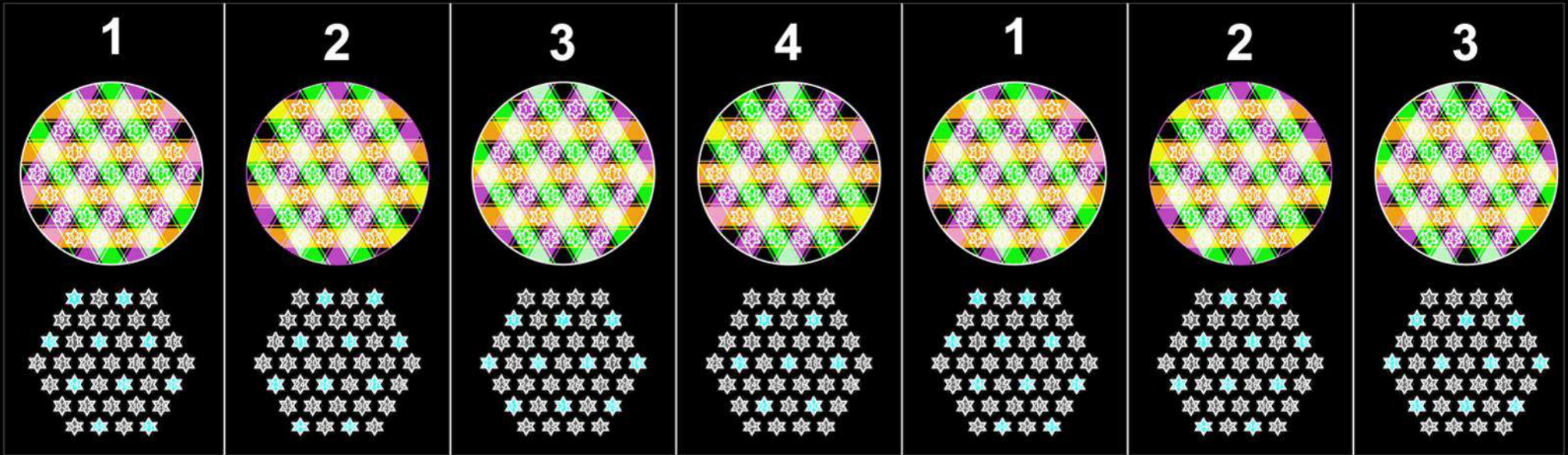



Dstar6\_37p\_min180\_7s\_triangle\_prop1

© Ignitions 2014

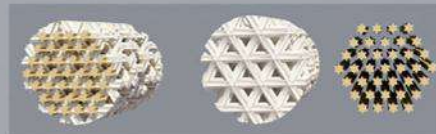

Dstar6\_37p\_min180\_7s\_triangle\_prop1

© Ignitions 2014



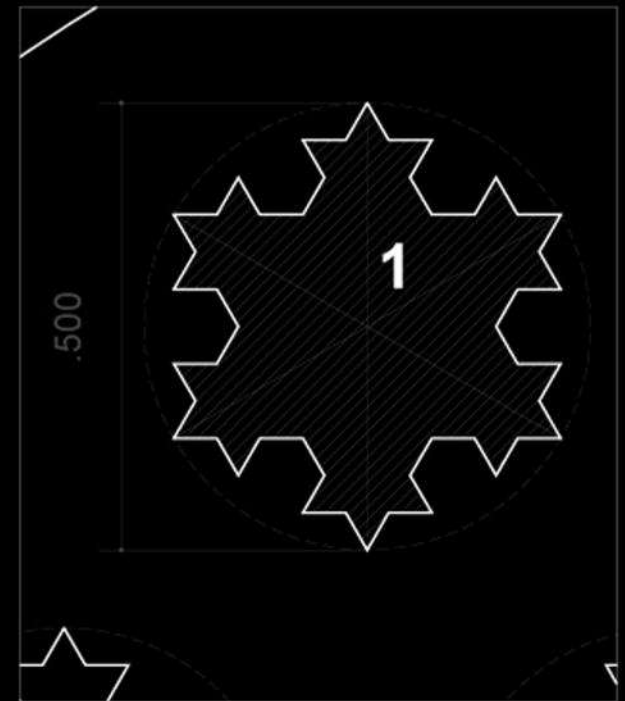
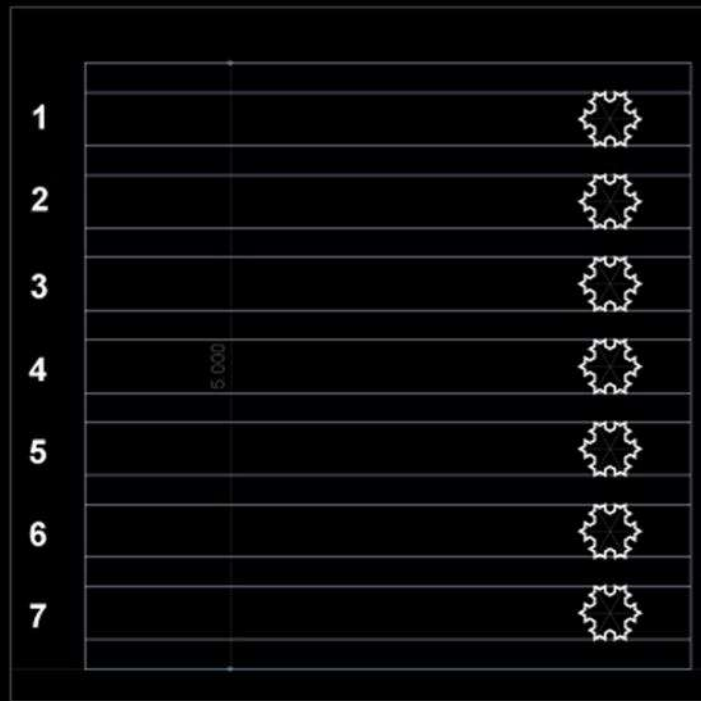
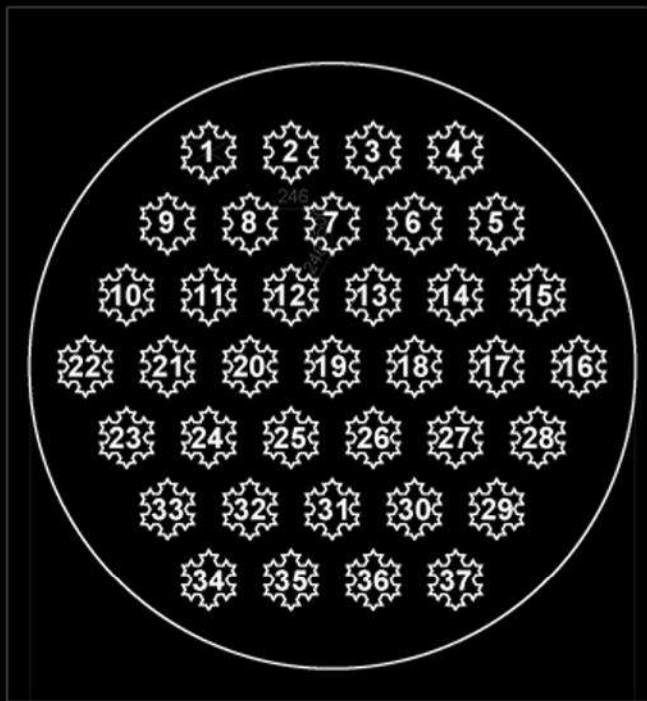
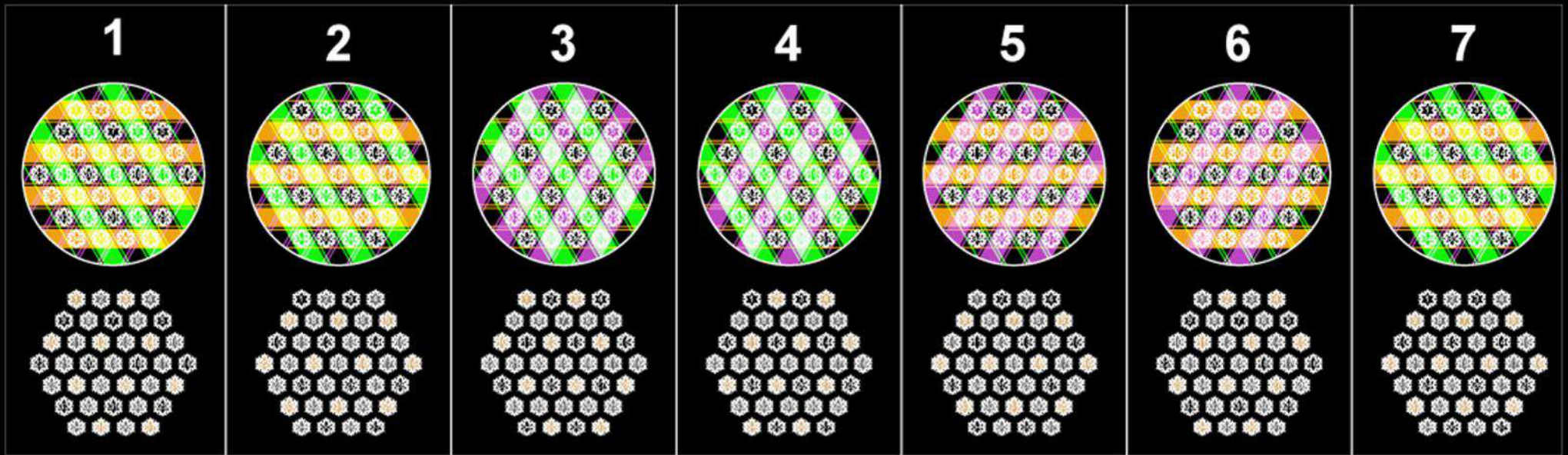

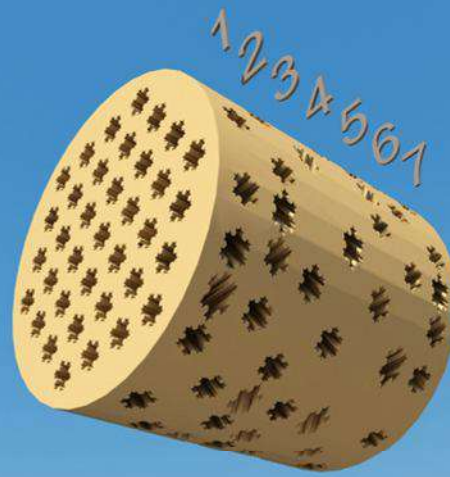
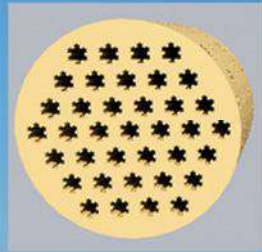

vonkoch\_star18\_37p\_min180\_7s\_rhombus\_prop1

© Igrations 2014

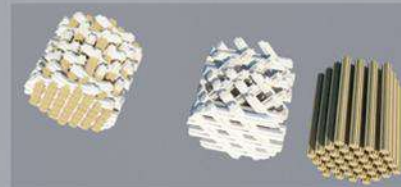

vonkoch\_star18\_37p\_min180\_7s\_rhombus\_prop1

© Igrations 2014





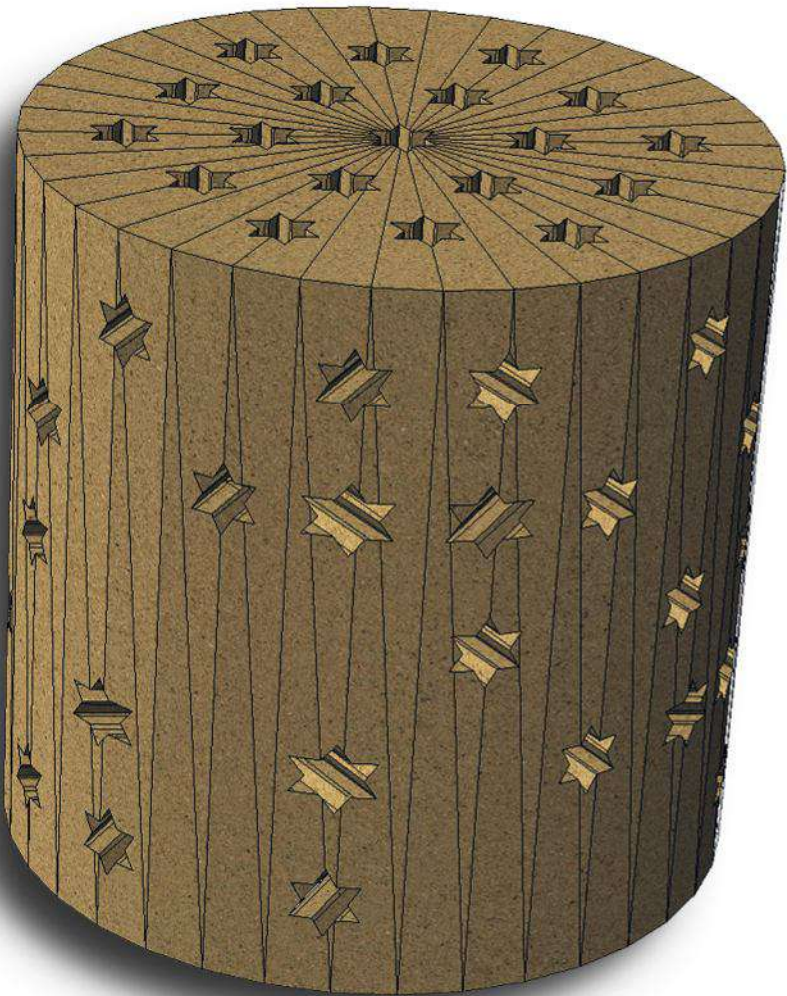

Dstar6\_19p\_min400\_5s\_rhombus\_prop1

© Ignitions 2014



1



2



3 (1)



4 (2)



5 (1)

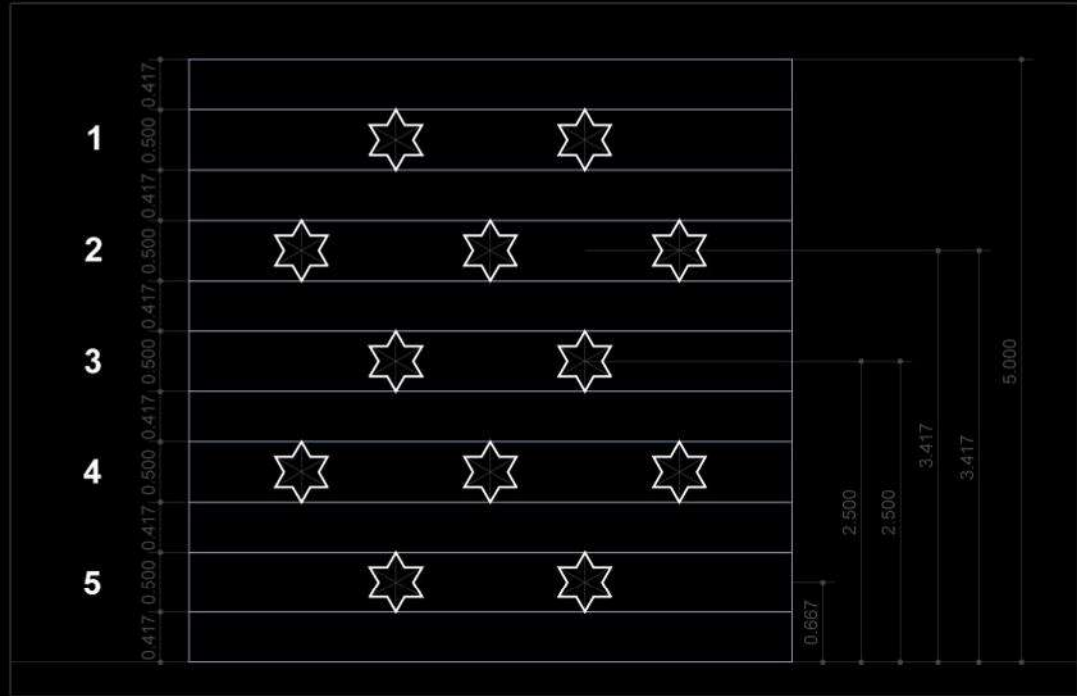
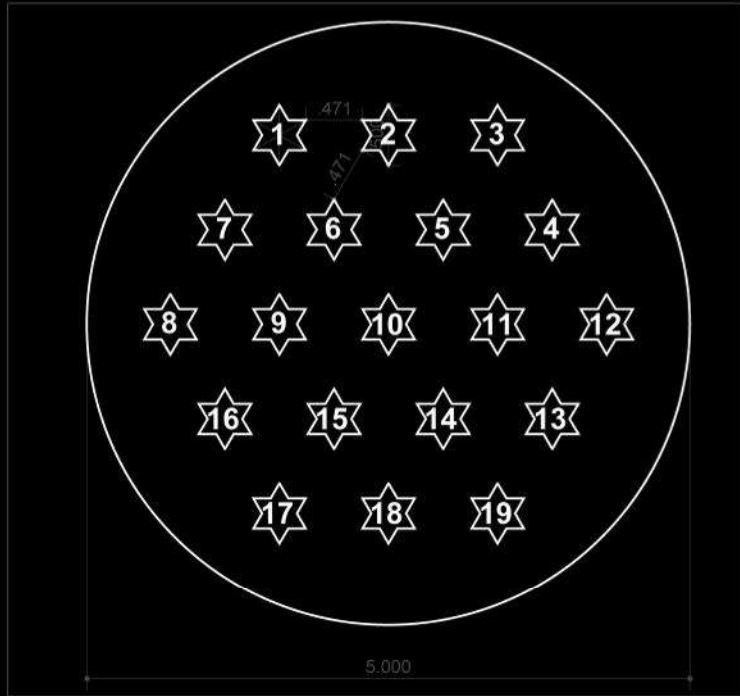
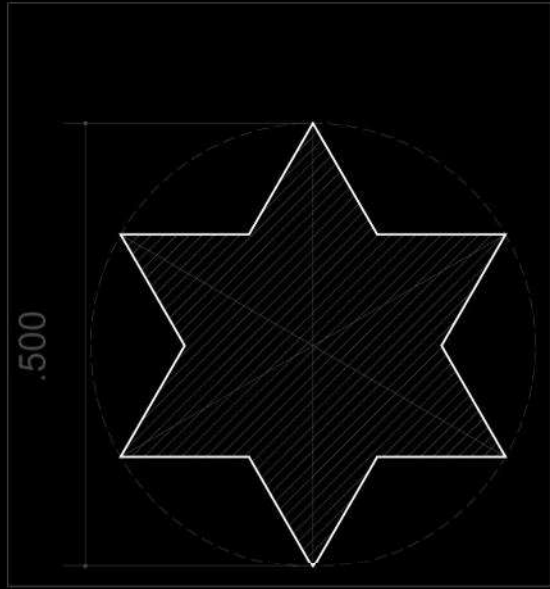
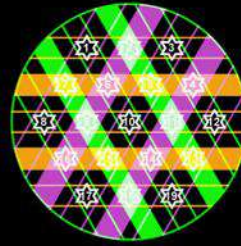

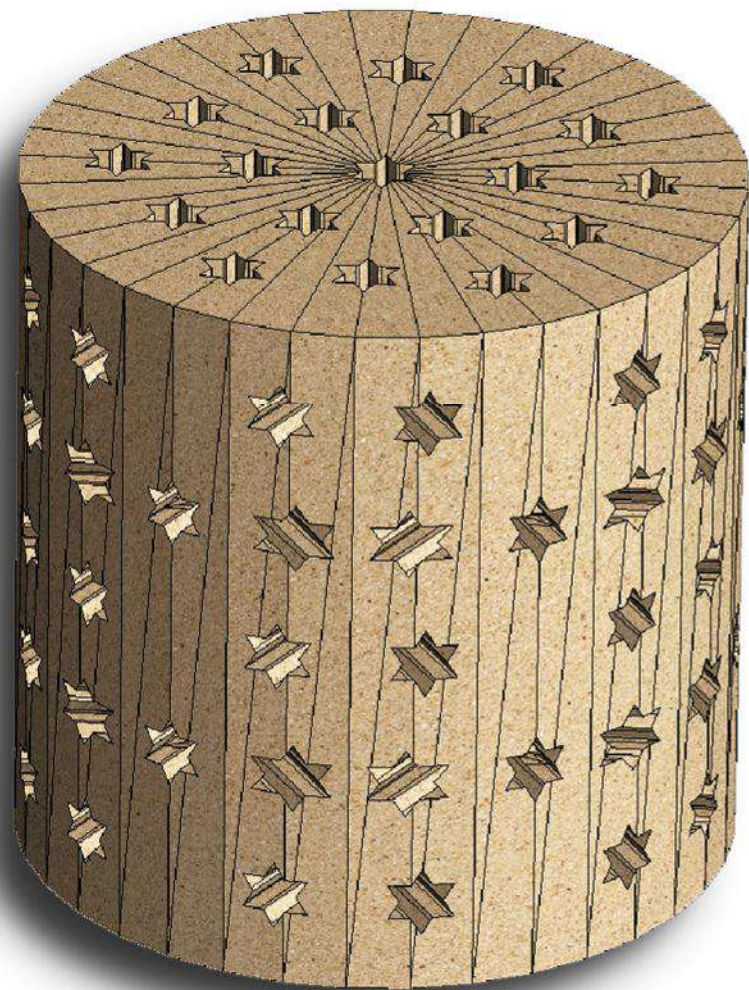

Dstar6\_19p\_min400\_5s\_triangle\_prop1

© Ignitions 2014





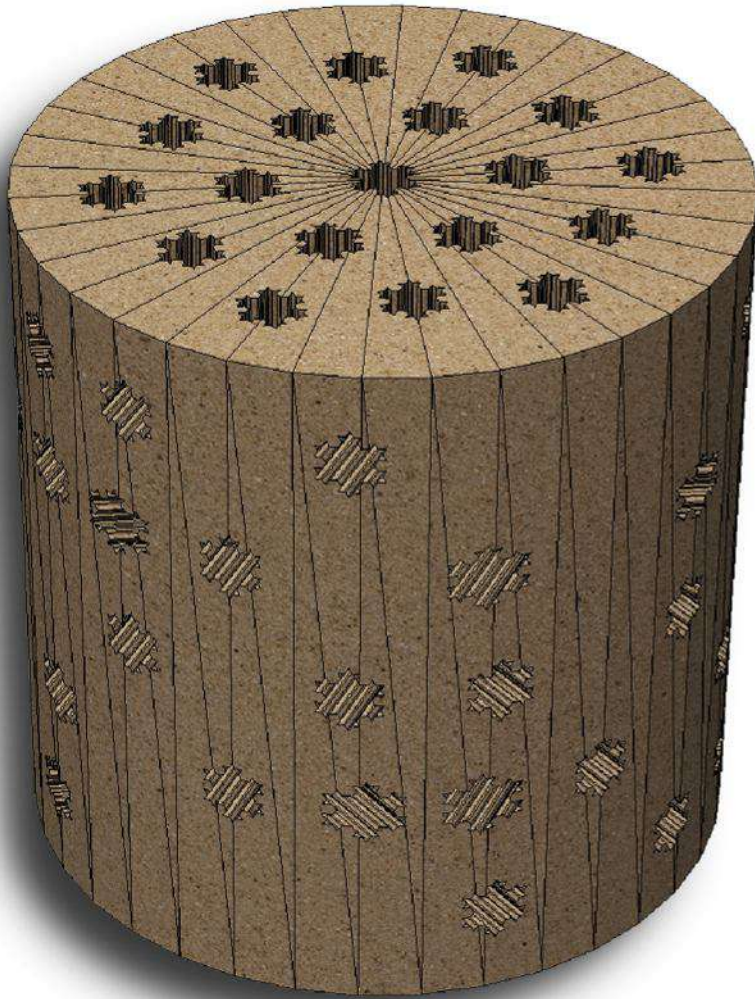

vonkoch\_star18\_19p\_400\_5s\_rhombus\_prop1

© Ignitions 2014



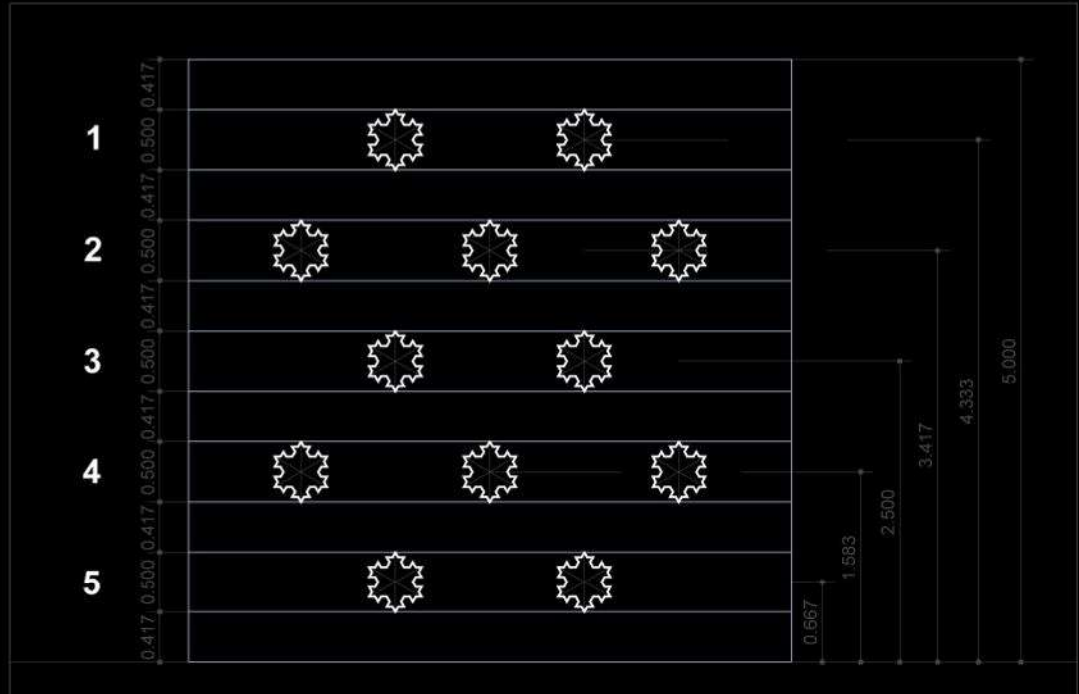
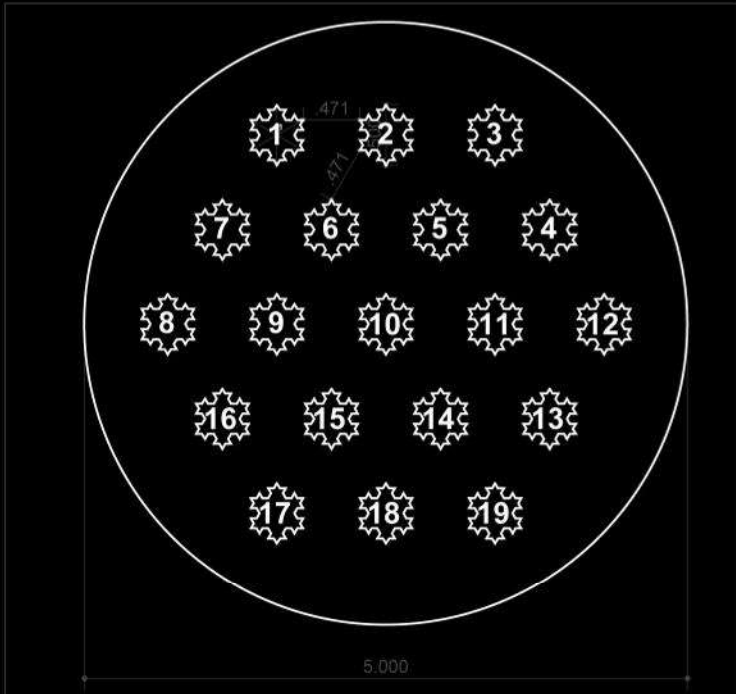
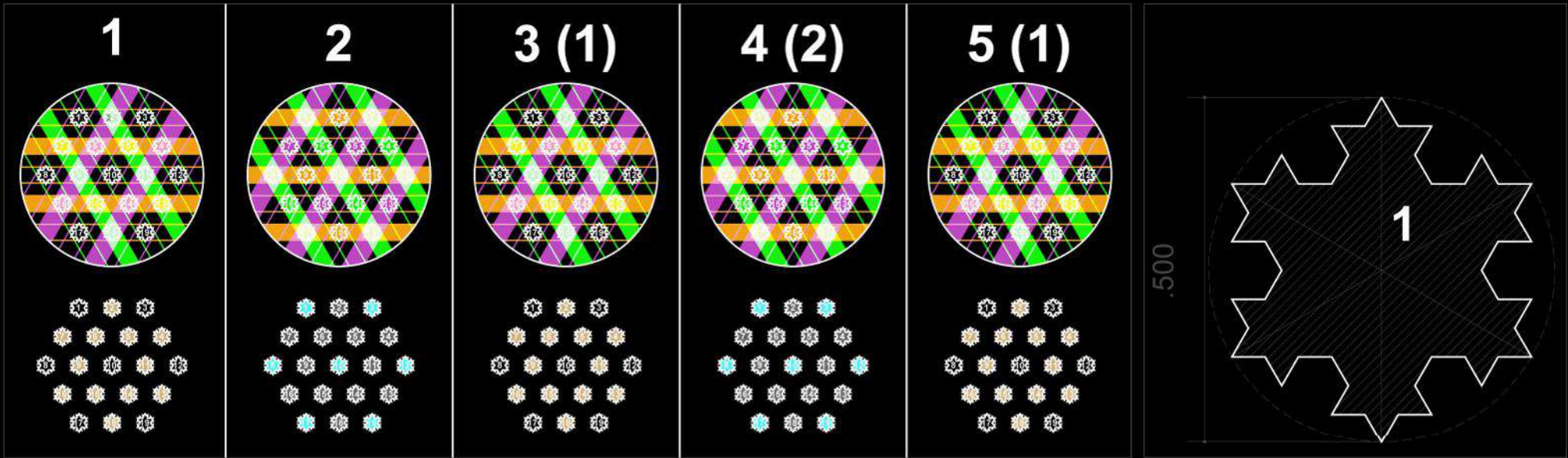

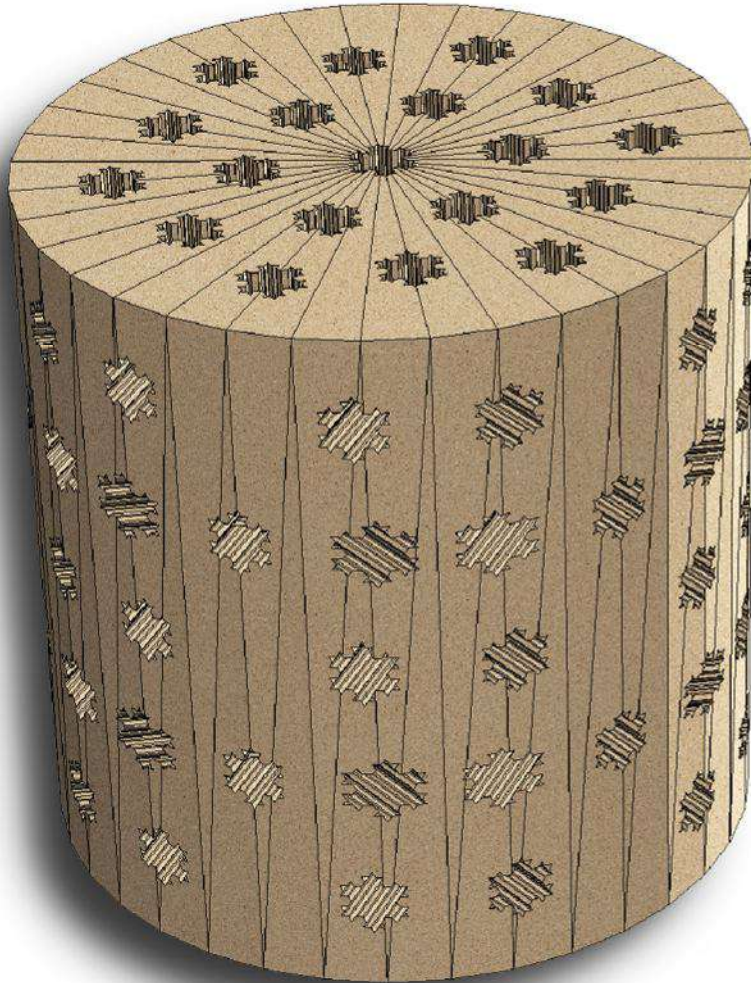

vonkoch\_star18\_19p\_min400\_5s\_triangle\_prop1

© Ignitions 2014



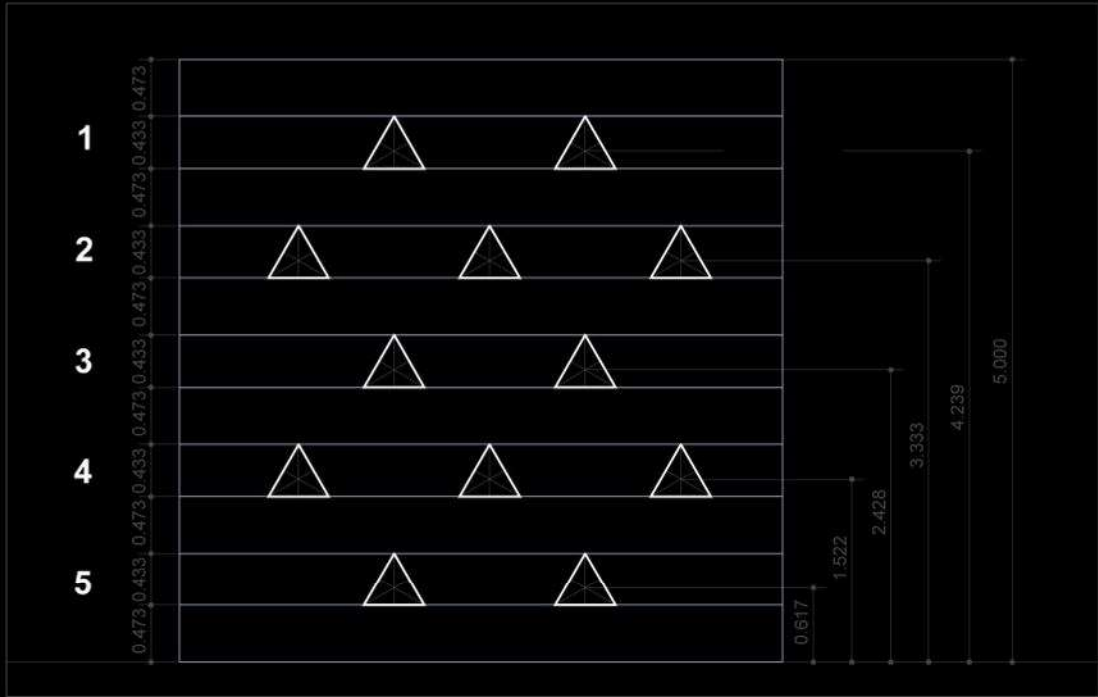
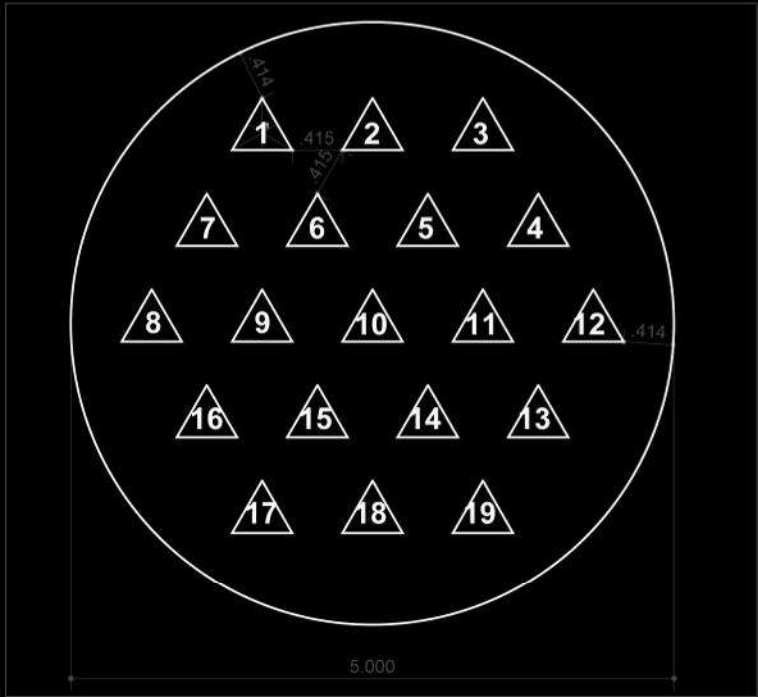
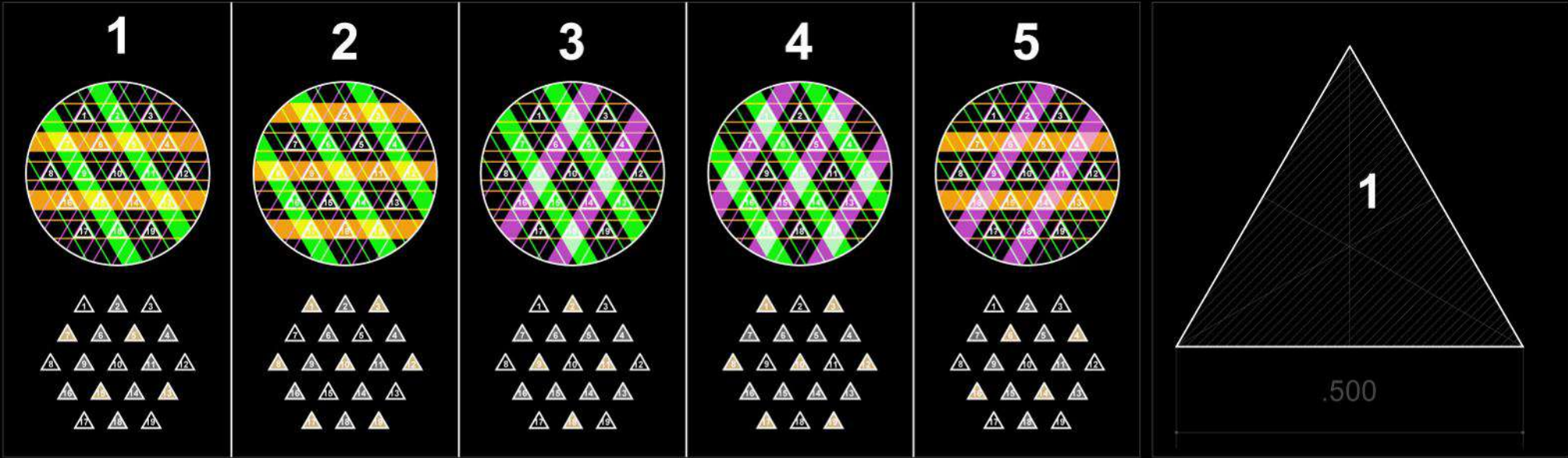

prisma\_19p\_400min\_5s\_rhombus\_prop1

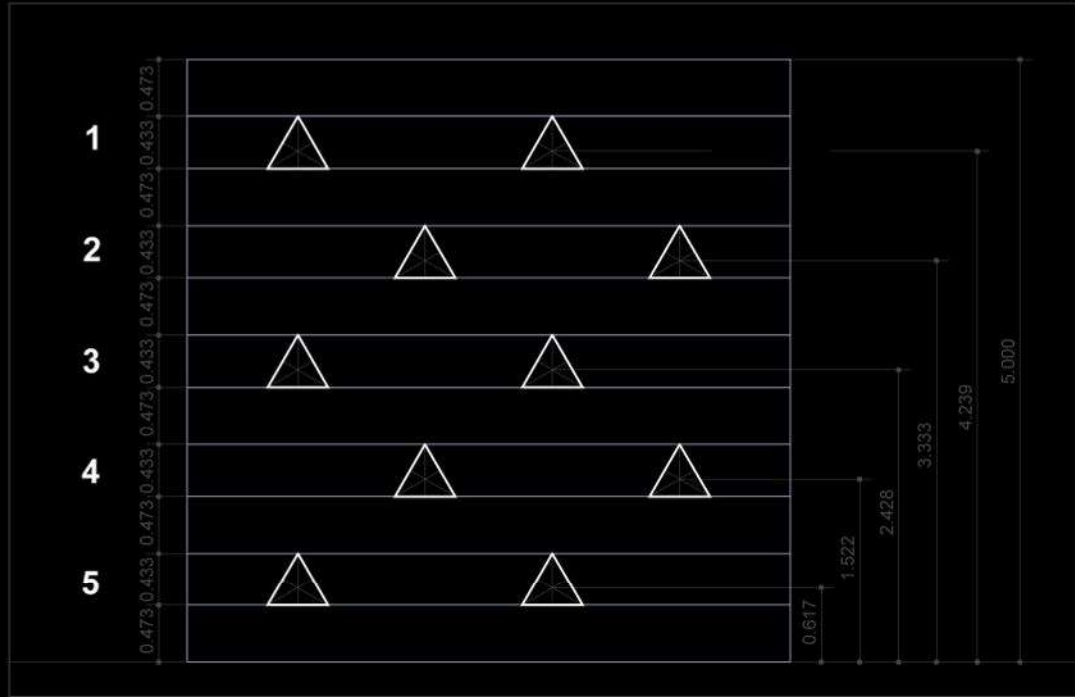
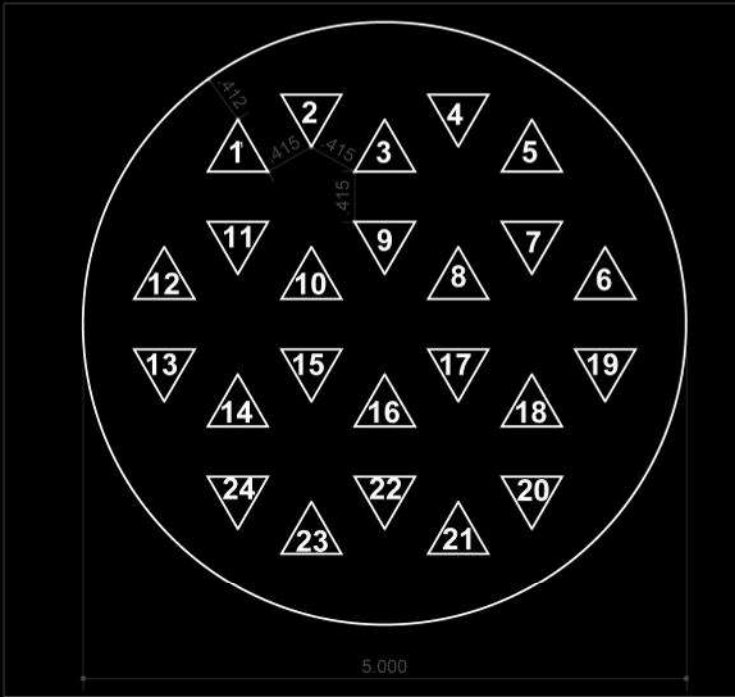
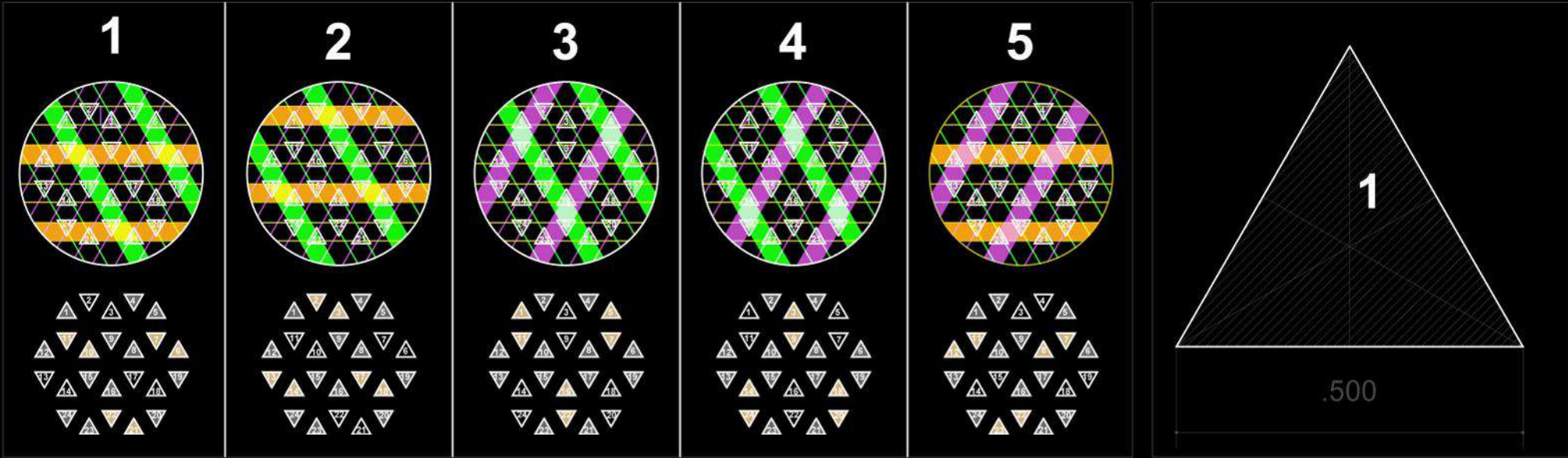

prisma\_24p\_400min\_5s\_rhombus\_prop2

© Ignitions 2014



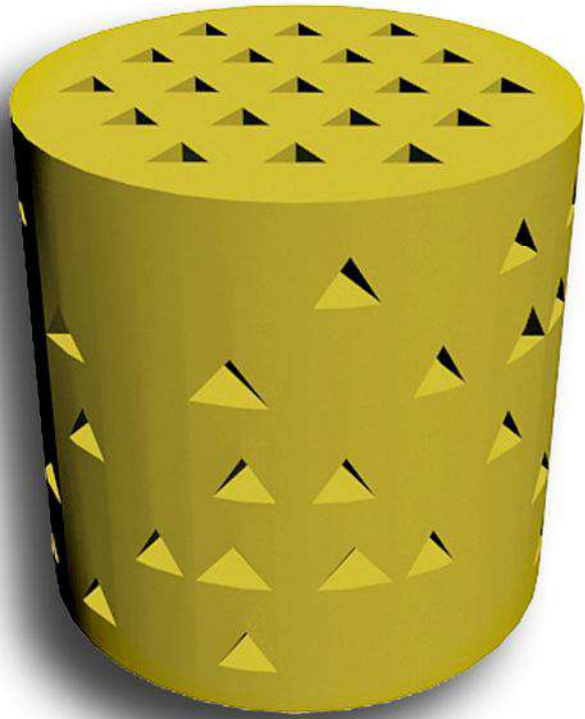

prisma\_19p\_min400\_5s\_rhombus\_prop1

© Ignitions 2014

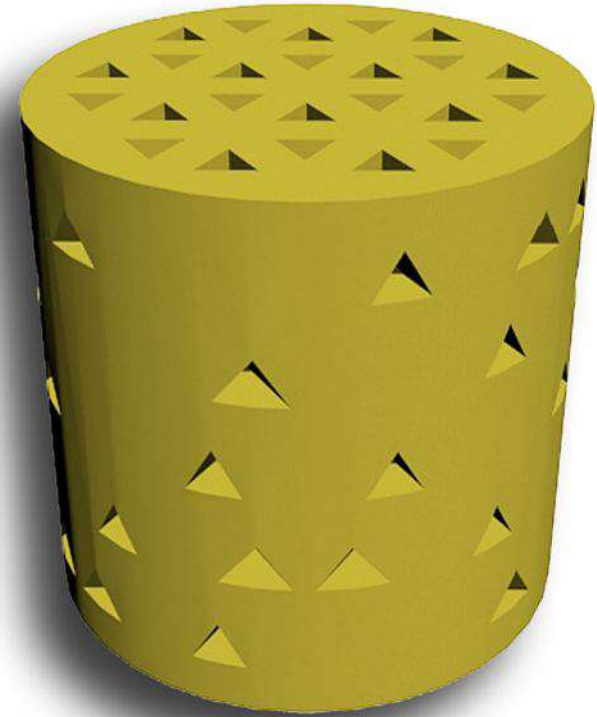

prisma\_24p\_min400\_5s\_rhombus\_prop2

© Ignitions 2014

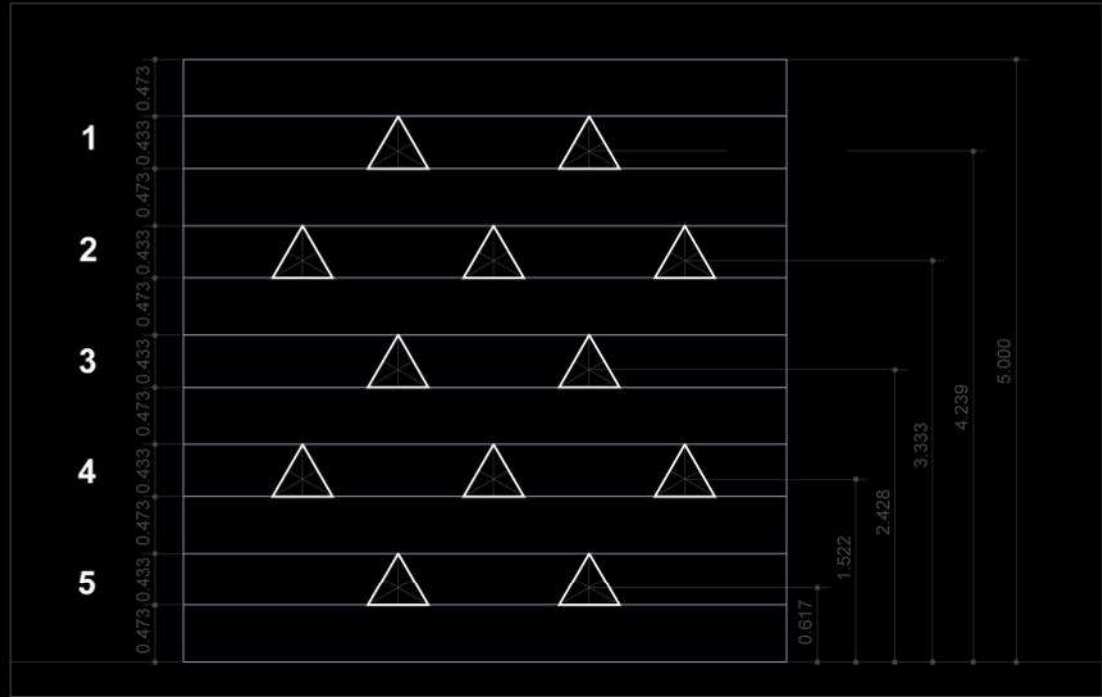
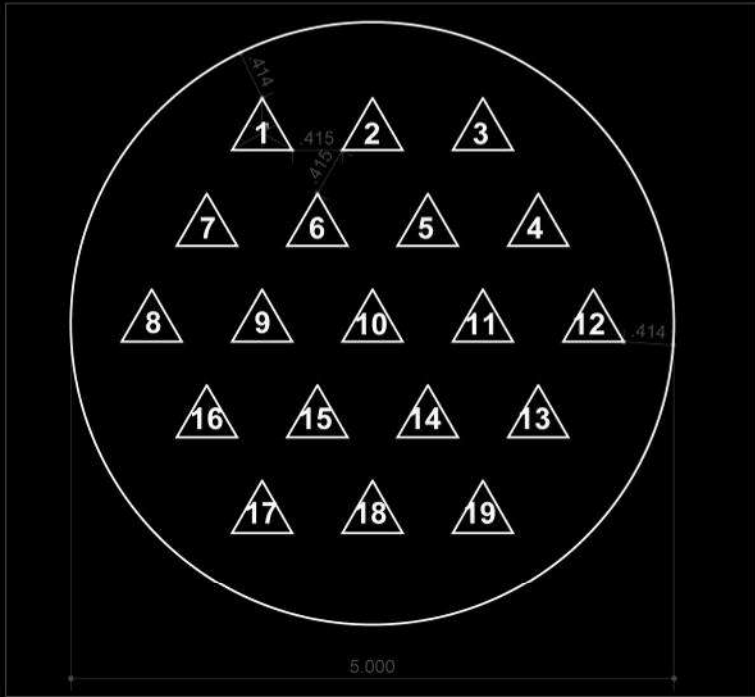
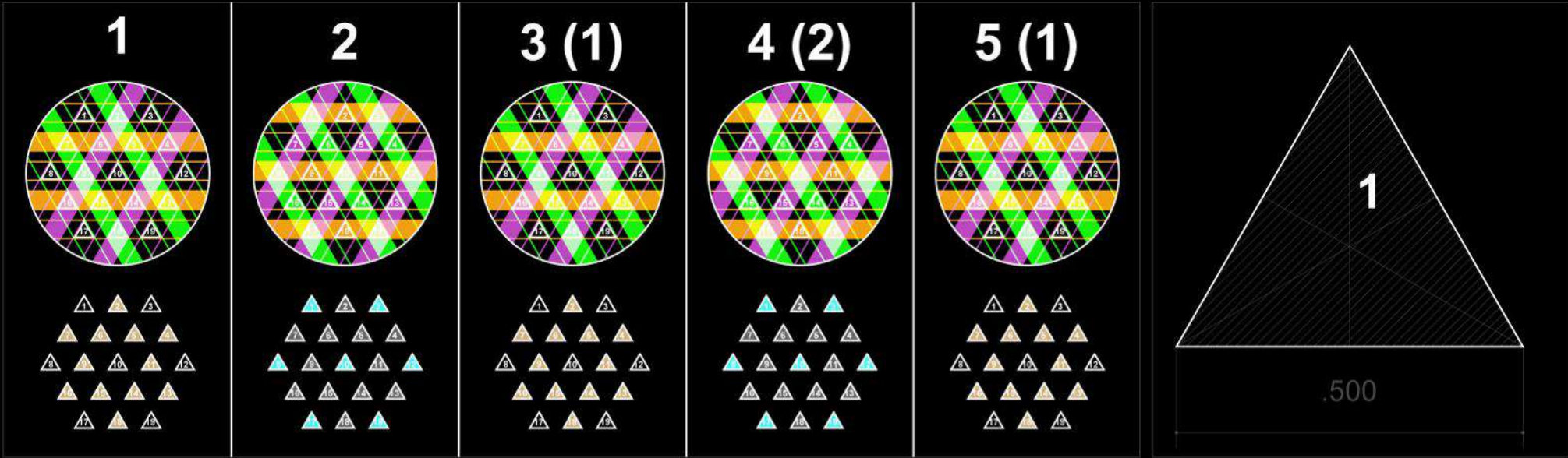

prisma\_19p\_400min\_5s\_triangle\_prop1



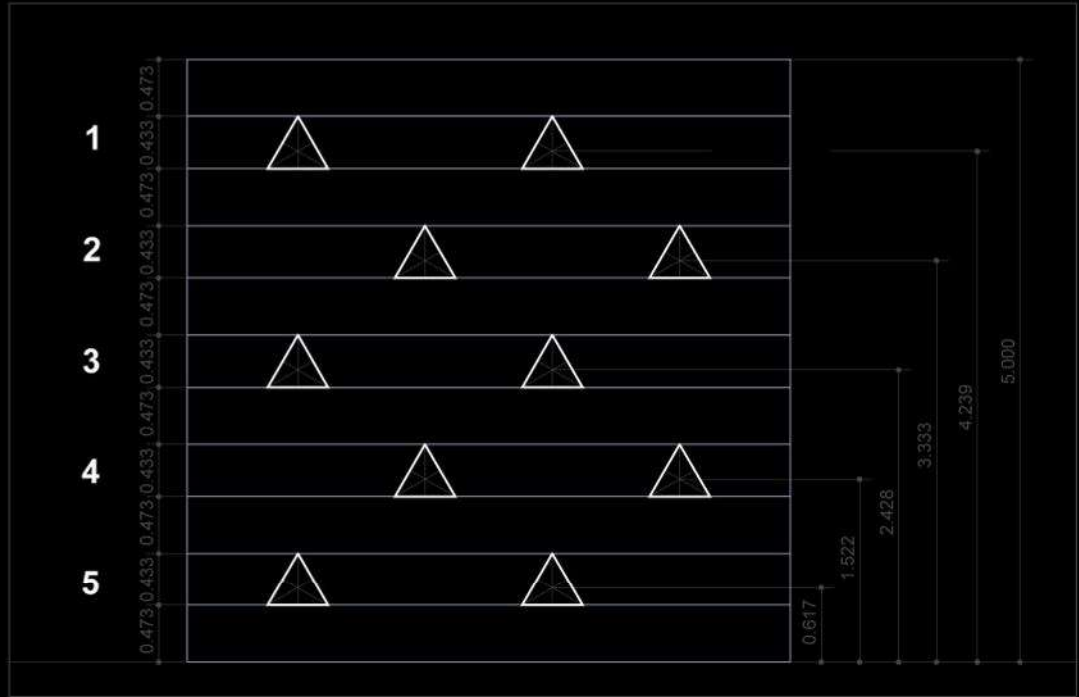
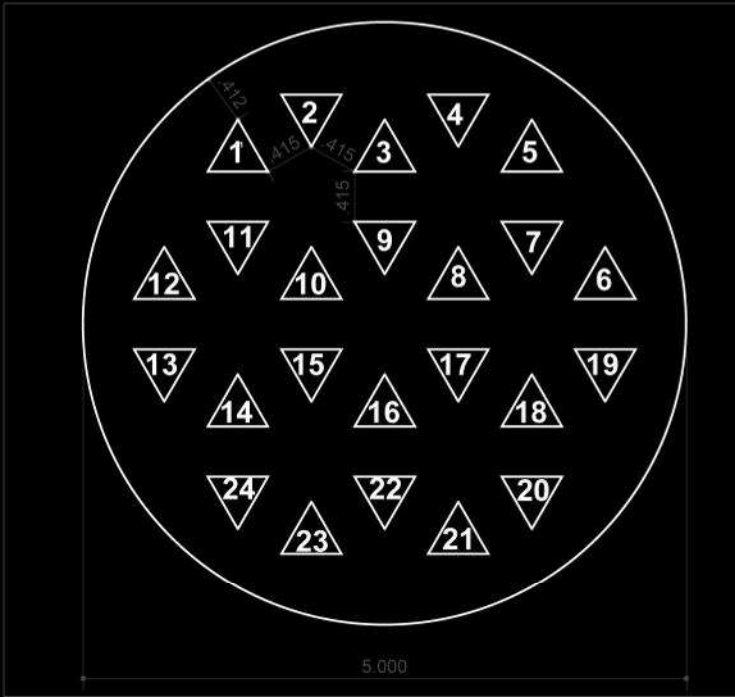
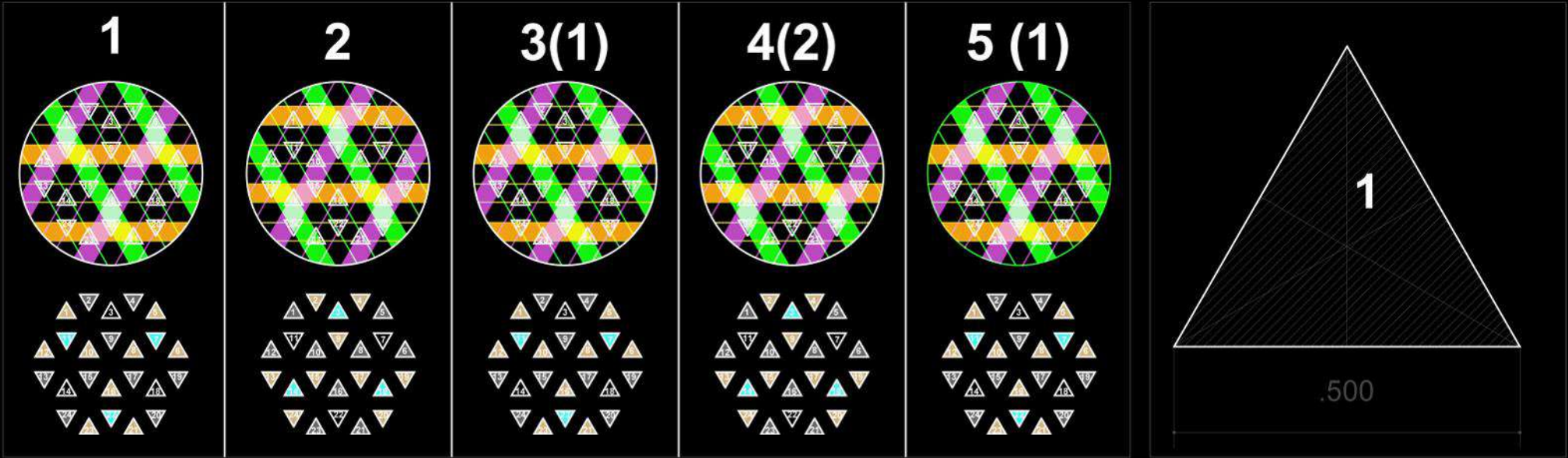

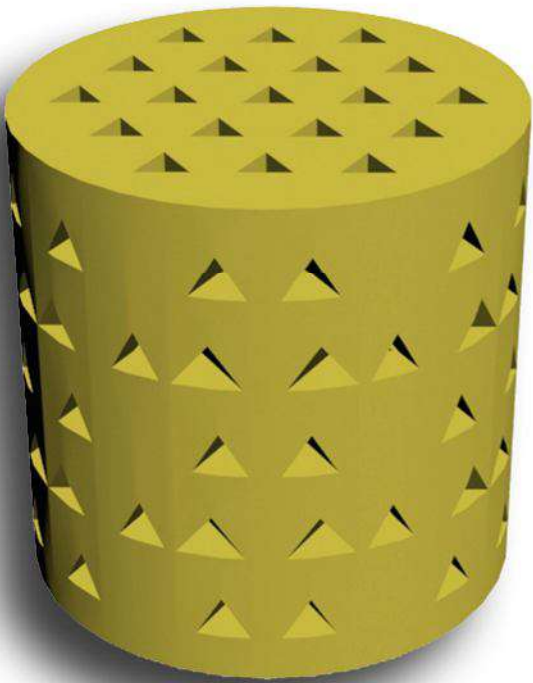

prisma\_19p\_min400\_5s\_triangle\_prop1

© Ignitions 2014

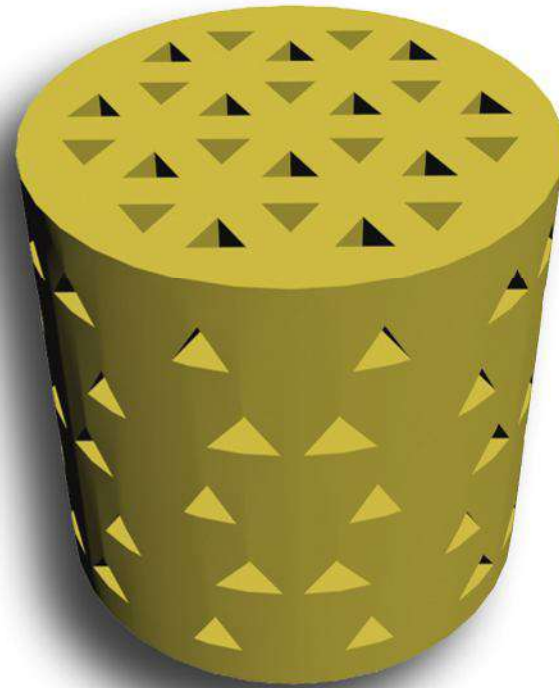

prisma\_24p\_min400\_5s\_triangle\_prop2

© Ignitions 2014



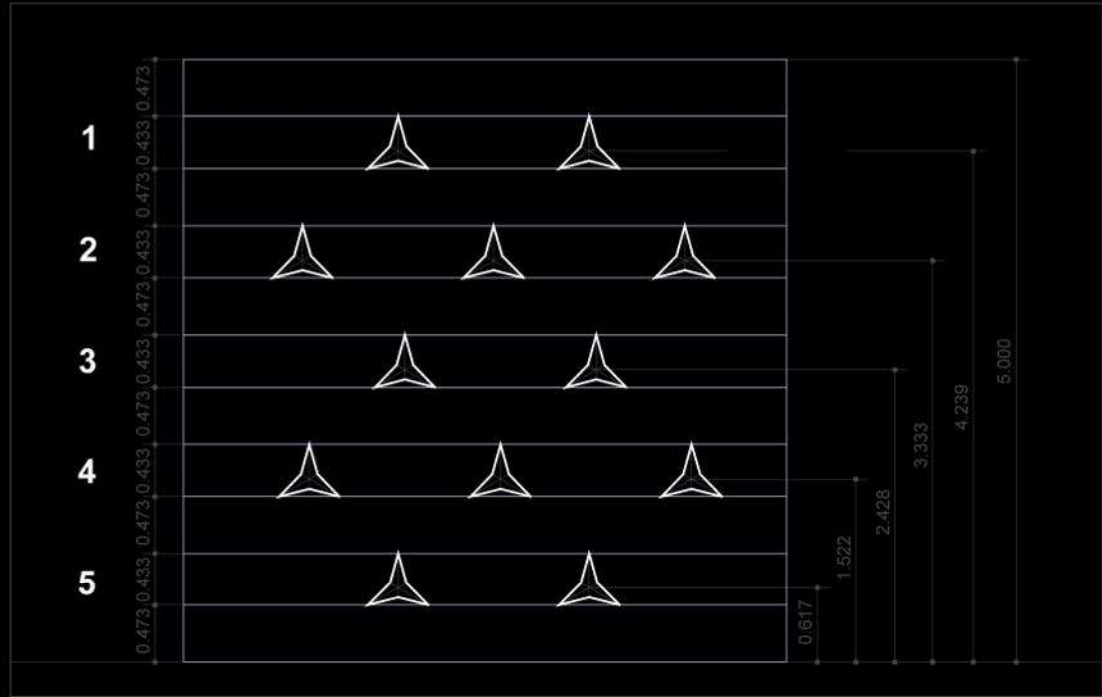
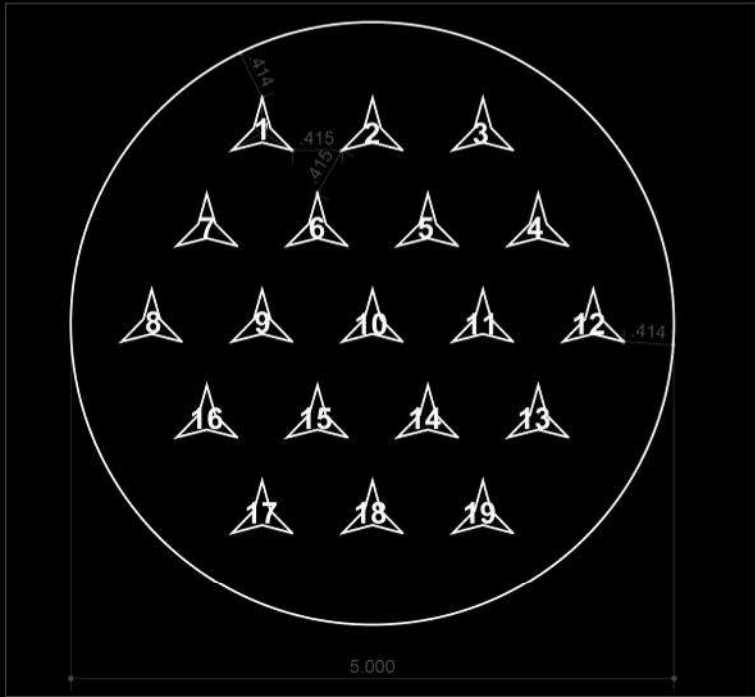
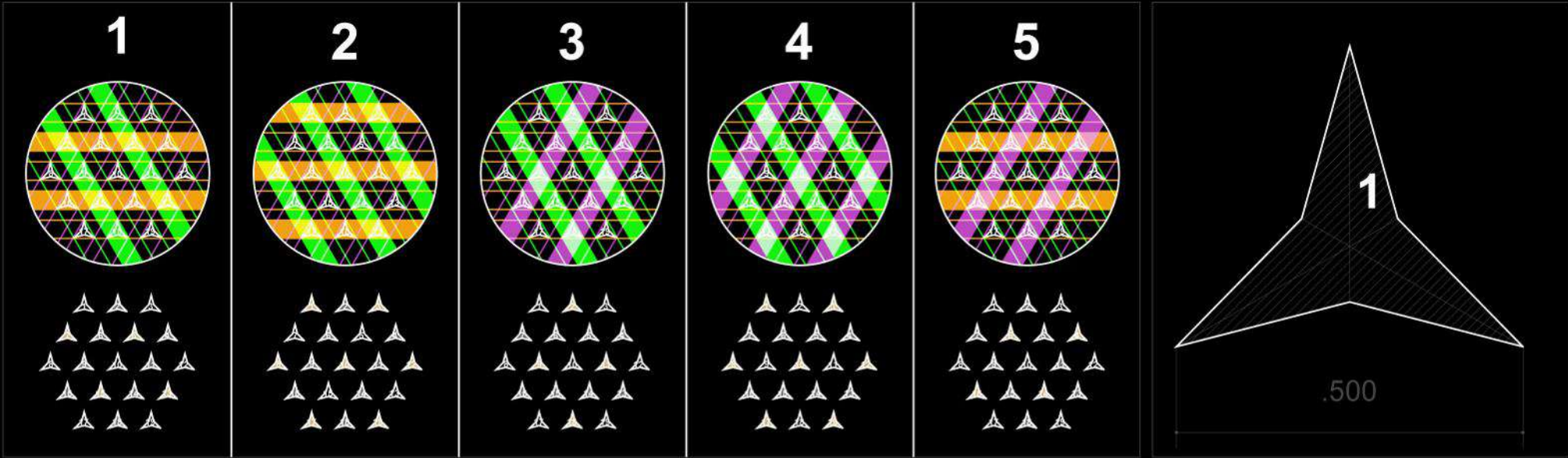

Dstar\_19p\_400min\_5s\_rhombus\_prop1

© Ignitions 2014

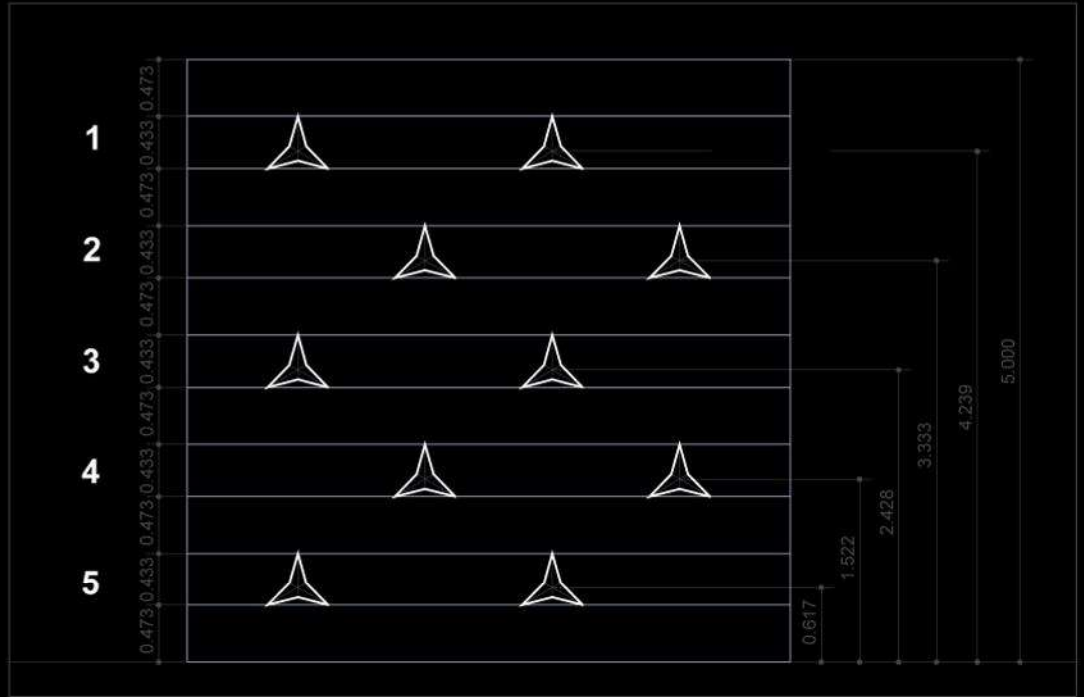
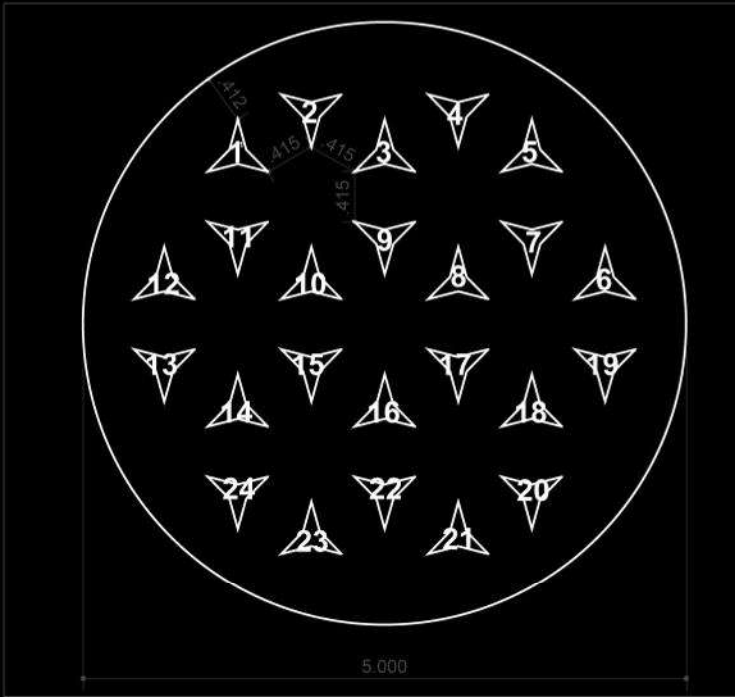
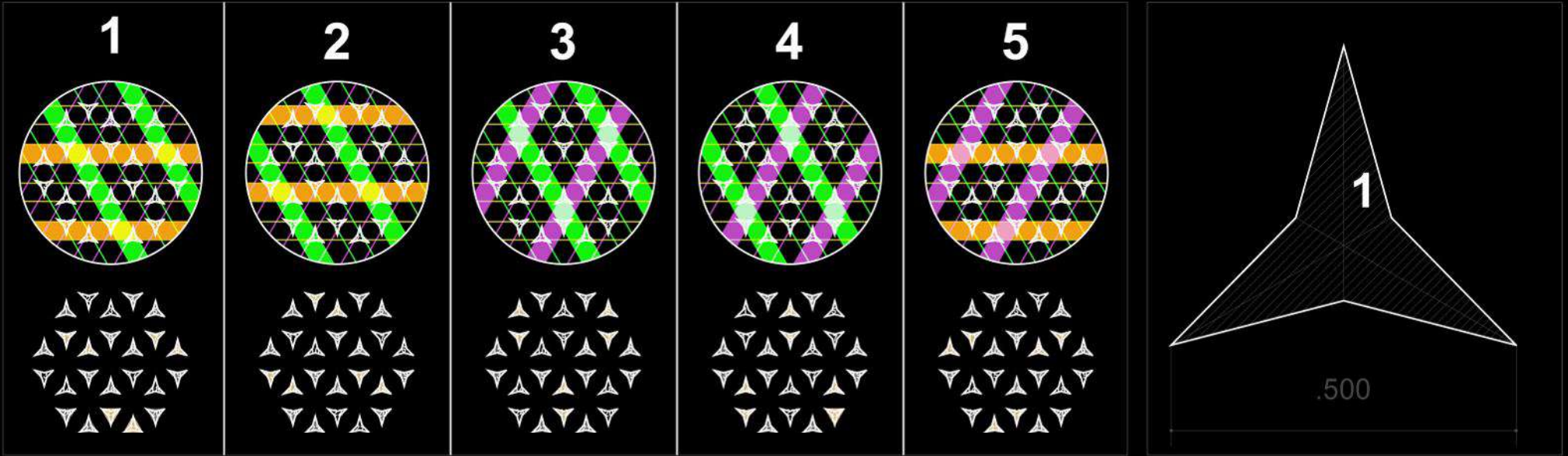

Dstar\_24p\_400min\_5s\_rhombus\_prop2



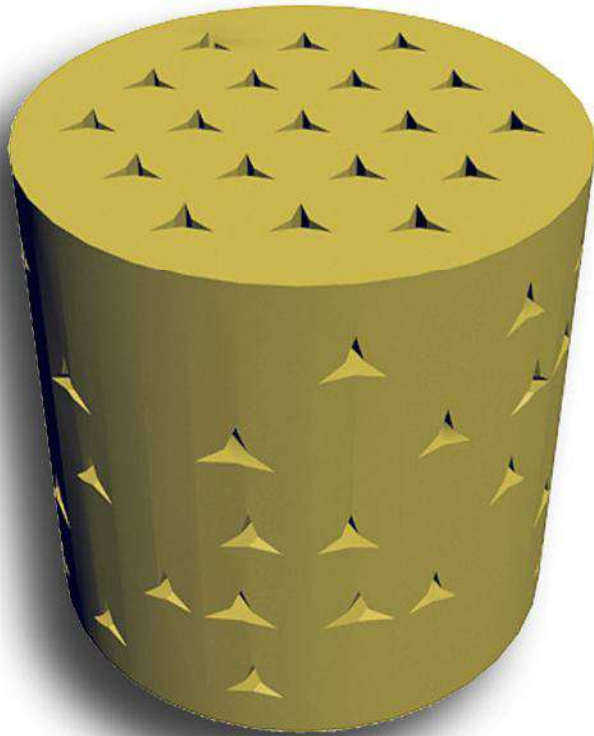

Dstar\_19p\_min400\_5s\_rhombus\_prop1  
© Ignitions 2014

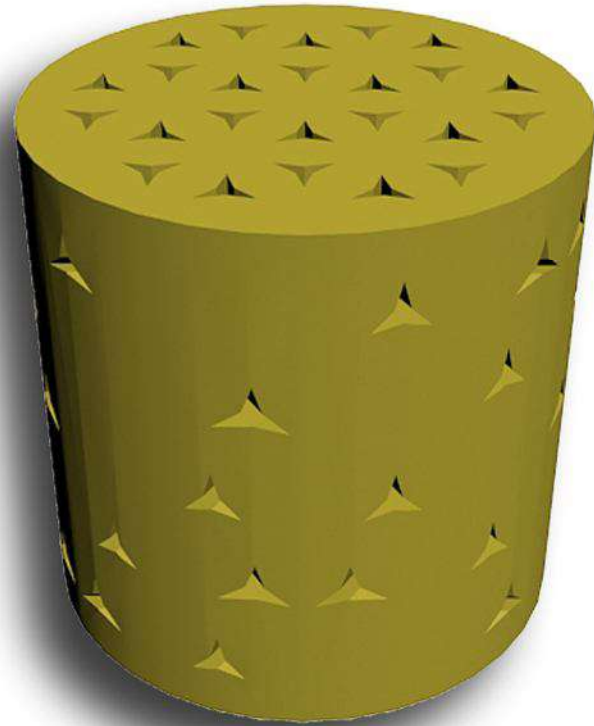

Dstar\_24p\_min400\_5s\_rhombus\_prop2  
© Ignitions 2014

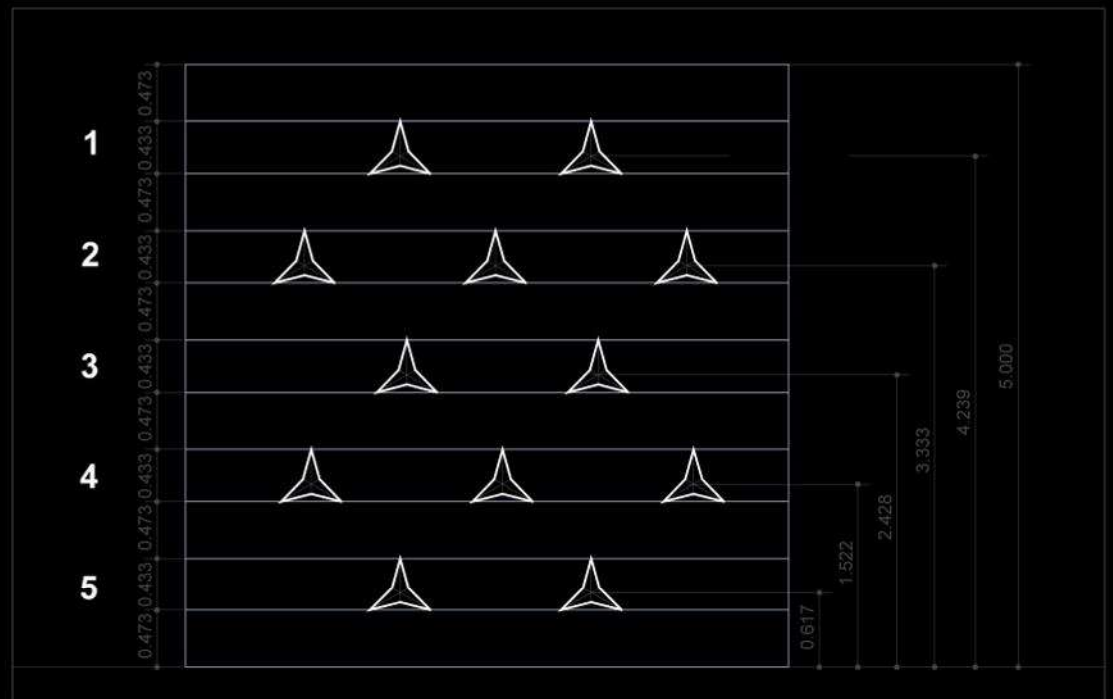
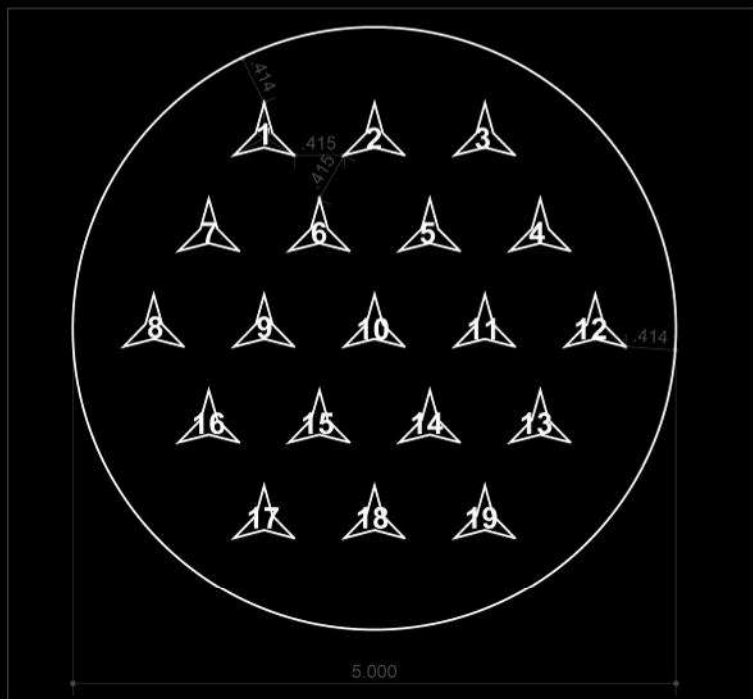
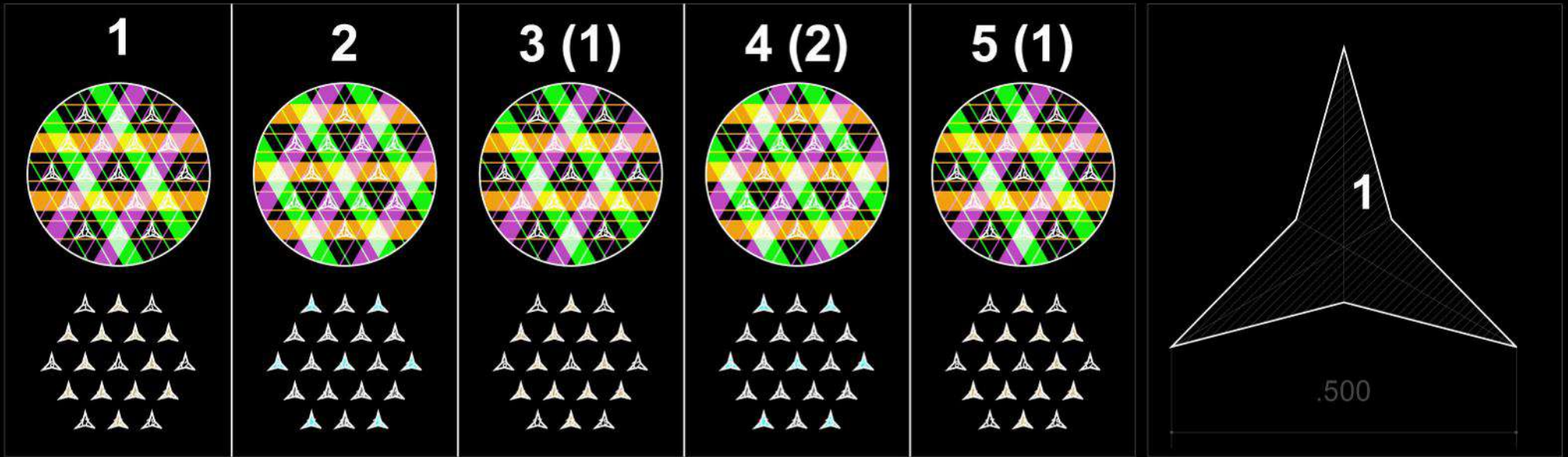

Dstar\_19p\_400min\_5s\_triangle\_prop1

© Ignitions 2014



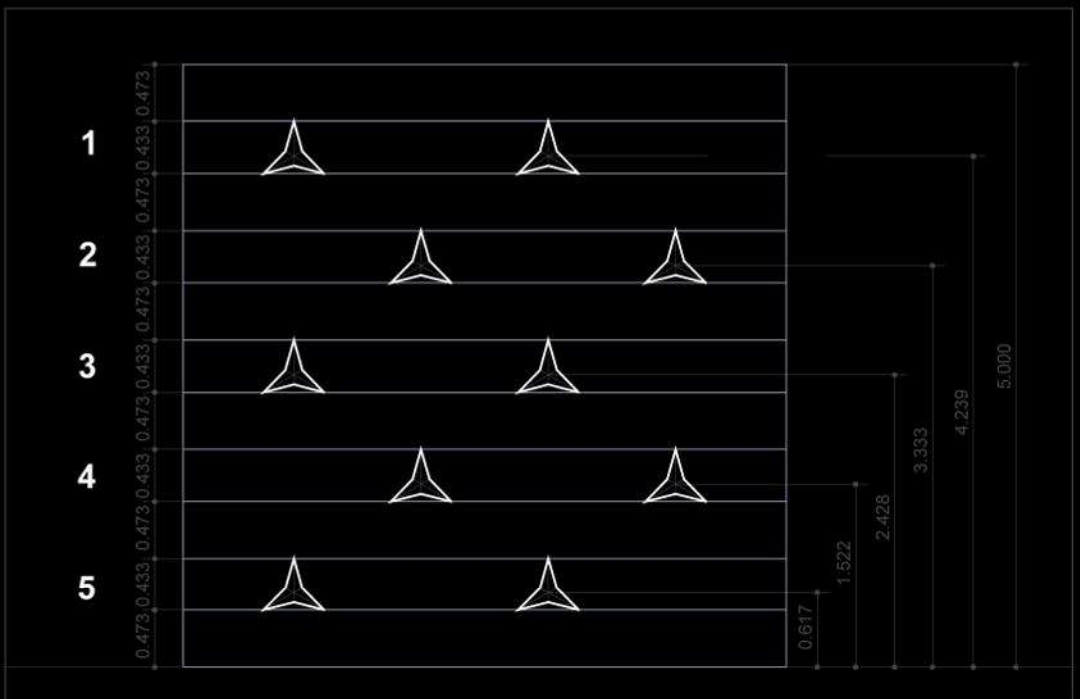
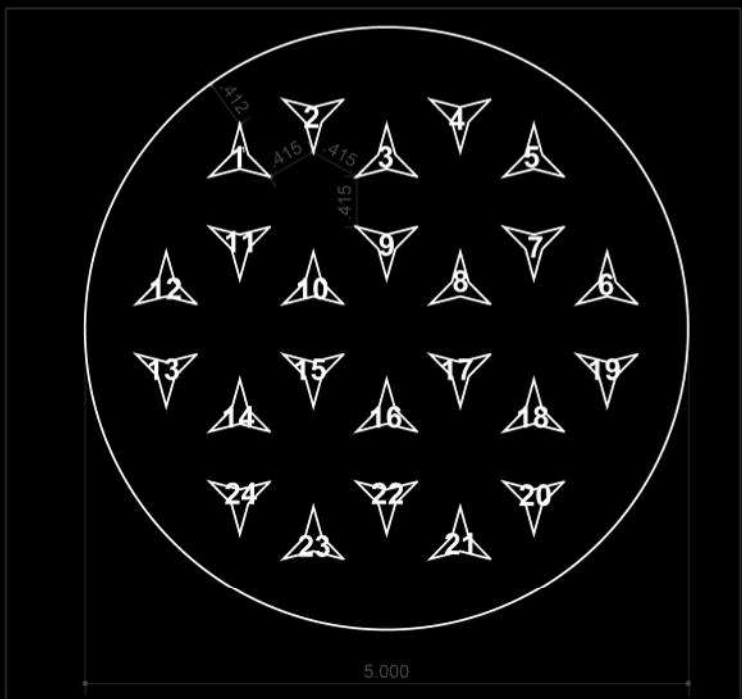
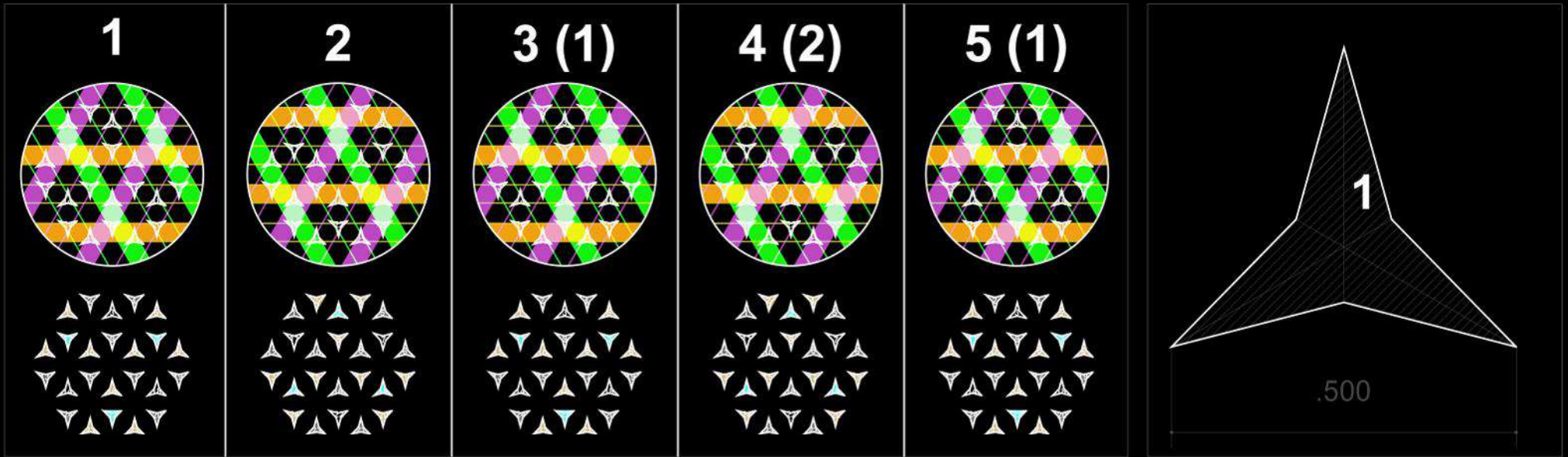

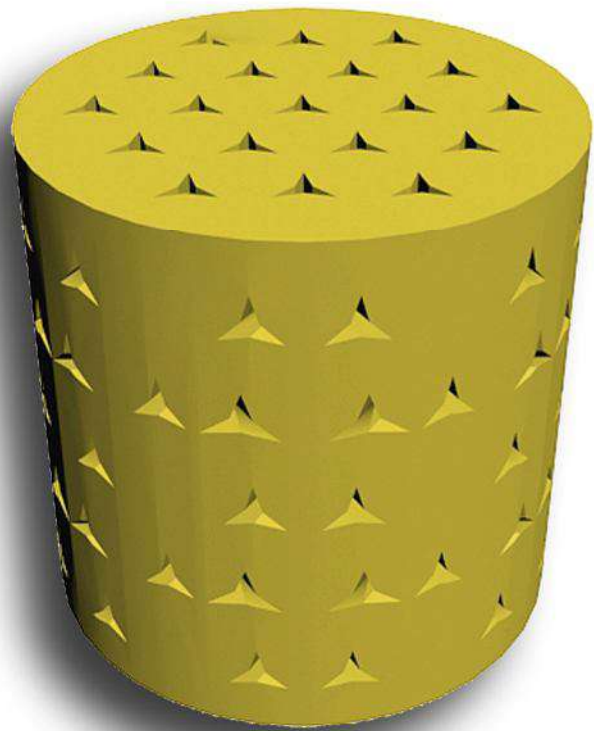

Dstar\_19p\_min400\_5s\_triangle\_prop1  
© Ignitions 2014

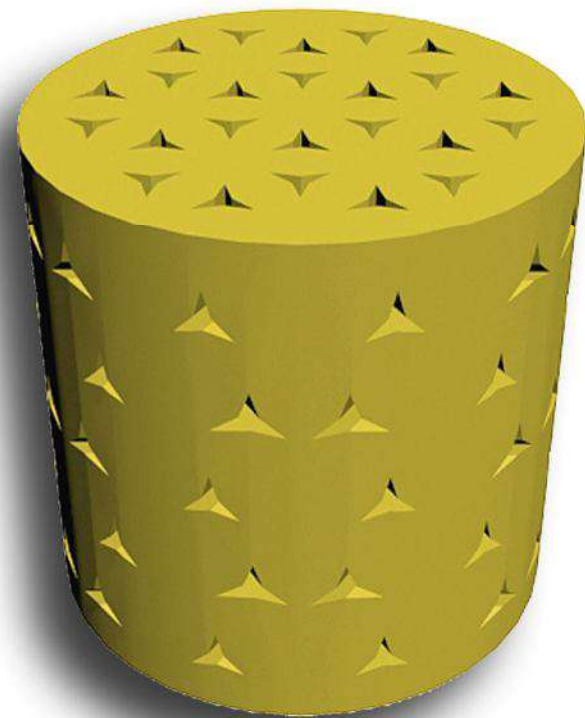

Dstar\_24p\_min400\_5s\_triangle\_prop2  
© Ignitions 2014